



2-zone application

2x T6RWP thermostat and 2-channel receiver box

With the 2-channel Receiver box (R6H911RF) and 2x a T6RWP wall powered wireless smart thermostats (T6H700RW) automatic time and temperature control of 2 heating zones and a boiler for homes and apartments can be managed.

It's compatible with 24-230V on/off such as gas boilers or OpenTherm® appliances such as combi-boilers or heat pumps. Also, works with zone valve applications and is suitable for Sundial S, Y and W plan stored hot water systems (on/off). Not with electric heating (240V).

The solution is designed with the installer in mind. The 2-channel Receiver box offers mounting options for directly on the wall or on a wall box. Wiring can be from below or from the back by lifting the terminal platform, which makes installation quick and easy.

The T6RWP smart thermostat is designed for wall mounted installations and works wirelessly with the Receiver module.

The T6RWP consist of a thermostat and in wall power module, which fits in a standard wall box.

The thermostat has a high contrast PMVA display with dynamic text line and touch screen buttons. The thermostat has a simple programming philosophy to make it easier to install and very user friendly.

The 2-zone solution is ideal for consumers who want to split the comfort control of their home in 2 areas, like upstairs and down-stairs or a living and working area.

The solution offers remote comfort control of both zones via the Honeywell Home app.



2x T6RWP wireless and 2-channel Receiver box

FEATURES & BENEFITS

T6RWP Smart Thermostat

- Attractive, ultra-modern styling makes it ideal for any location in any type of home.
- Wall mounted thermostat to fit a new and replacement installations where 230V is available.
- Wi-Fi communication to connect to the Internet
 - Smart Home and Apple HomeKit ready
- Honeywell Home mobile App for:
 - Schedule changes
 - Smartphone Geolocation temperature control
- A dynamic text display on the LCD that gives enhanced feedback to the user / installer.
- High LCD Contrast and backlighting for easier viewing in all light conditions.
- Time out screen with selectable brightness
- Schedule:
 - Factory programmed daily or 5+2 default schedule
 - Schedule with up to 6 independent time and temperature pairs to suit the comfort needs.
 - "Hold until" temperature override of programmed schedule temperature till the next switch point.
 - Schedule off mode for manual operation.
 - Setpoint and room temperature always displayed.
 - OFF position has an integral frost protection setting at minimum 5°C so that pipes in the house will never freeze in winter.
- Alert messages to assist in fault-finding.
- Requires to be bound with a Receiver box
- Advanced menu (Installer Set-Up) allows extra functions to be set at the discretion of the installer to match the consumer's applications and needs:
 - Language selection
 - System type
 - 5+2 or daily schedule option
 - Upper / Lower Set point Limit Adjust
 - Minimum ON time
 - Cycle rate
 - Factory Reset
 - Binding

2-channel Receiver box

- Clear LED indication of bound devices
- Override button per zone with LED indication
- Simple binding via override button
- A flip up wiring platform for easy wiring
- Pinhole for easy reset.
- 2 on/off relay outputs (zone valves)
- OpenTherm® compatible heating control output.

Thermostat Display/button Layout

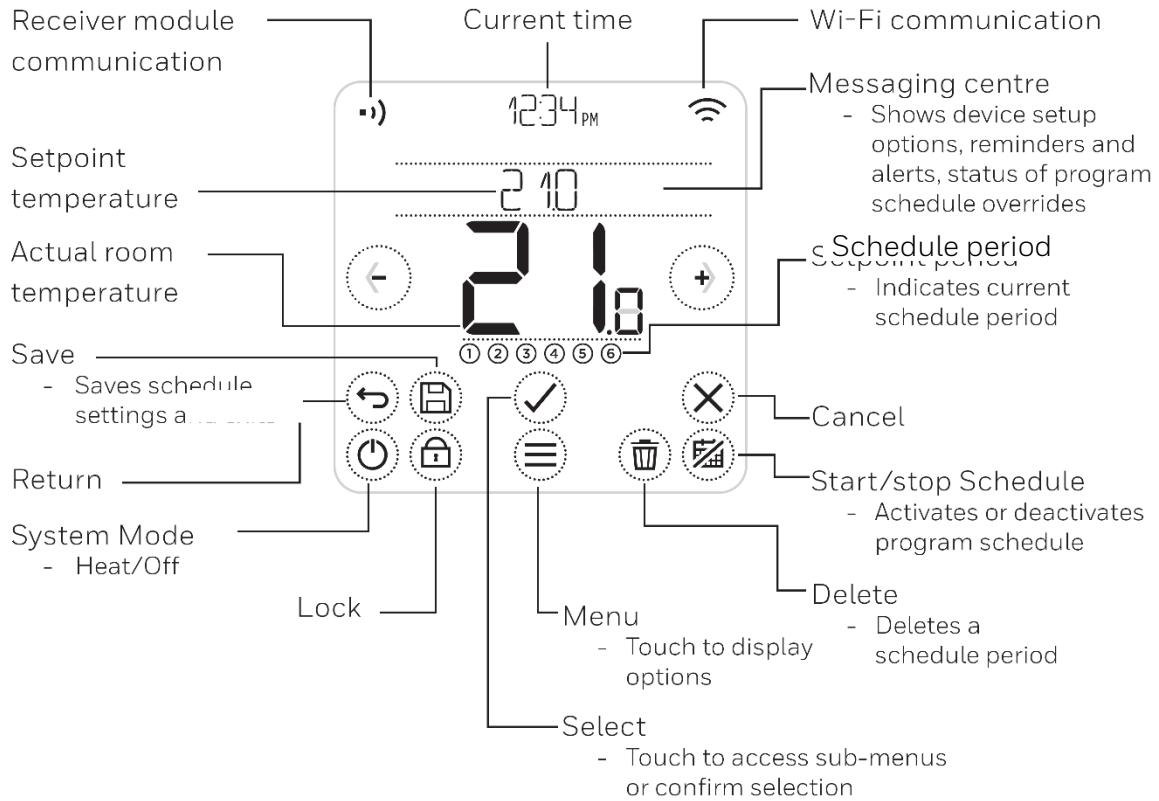

Reference to the icons:

- | | | | |
|--|-------------------------|--|-------------------------------|
| | Geofencing active | | Heating demand active |
| | Geofencing home active | | Hot Water Enabled |
| | Geofencing away active | | Heating Mode |
| | Geofencing sleep active | | Cooling Mode |
| | Failure/Alarm | | Receiver module communication |
| | Optimisation active | | Communication failure |
| | Schedule disabled | | Wi-Fi communication |
| | Schedule enabled | | Wi-Fi failure |
| | Temporary Hold active | | |

2-channel Receiver box

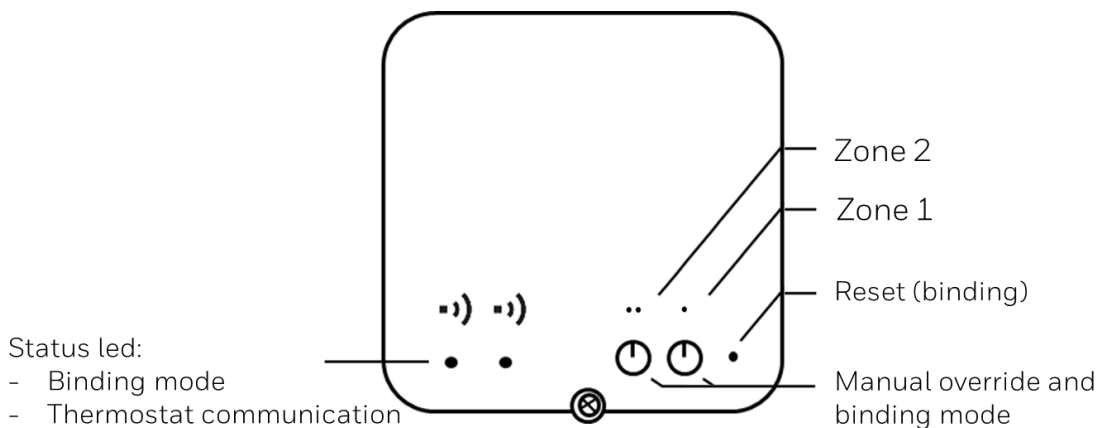

WIRING OPTIONS 2-CHANNEL RECEIVER BOX

Mounting and wiring 2-channel Receiver box

Note: For the wiring of the OpenTherm® boiler a separate cable is required.

A) Wiring 2 zone valves (230V) and basic 230V on/off boiler

Zone valve end switches used for controlling boiler (demand)

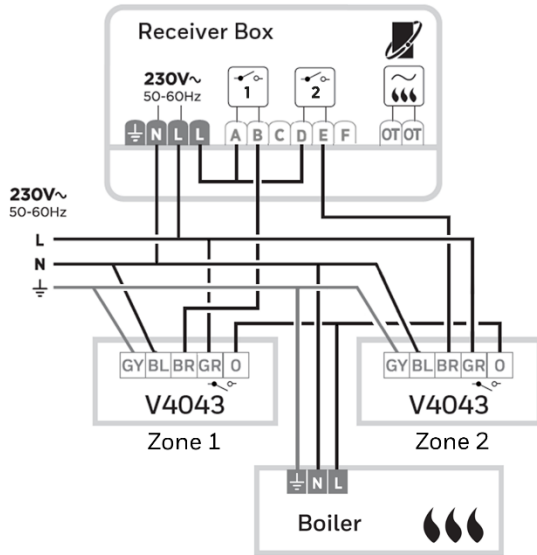

B) Wiring 2 zone valves (230V) and OpenTherm® boiler

Demand of zones used for controlling (modulating) OpenTherm® boiler

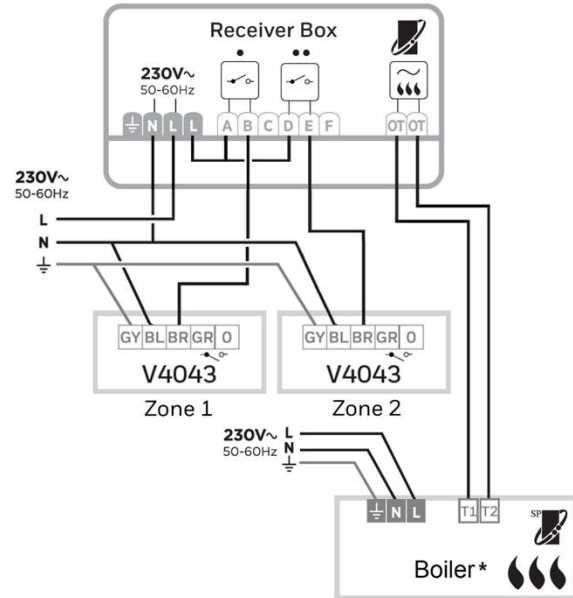

Find a suitable location near the boiler. Leave at least 30cm distance from any metal objects including wall boxes and boiler housing.

A. Power OFF

To ensure your safety, **always make sure mains power is switched OFF** before accessing wiring.

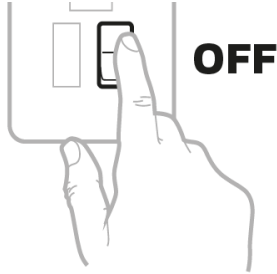

B. Opening and removing top cover

Loosen the front screw and hinge open to remove the top cover.

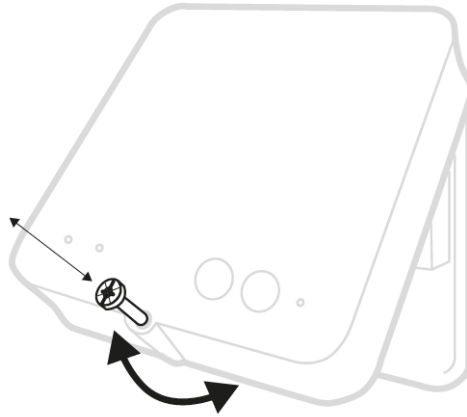

B. Wall box or Rear wiring

Hinge open the terminal block flap to access the cables and wall box screw holes.

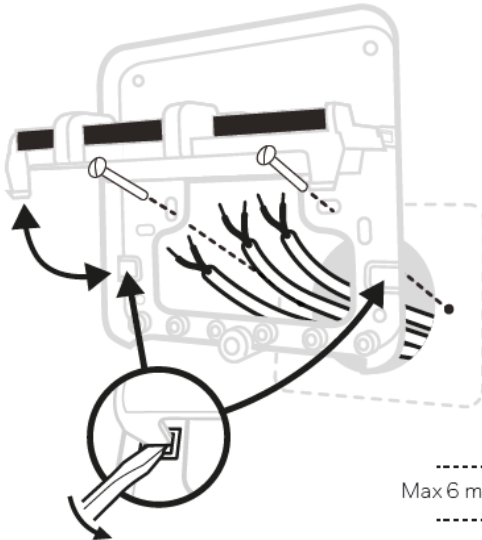

D. Surface wiring

Use the cable clamps to secure the surface wiring.

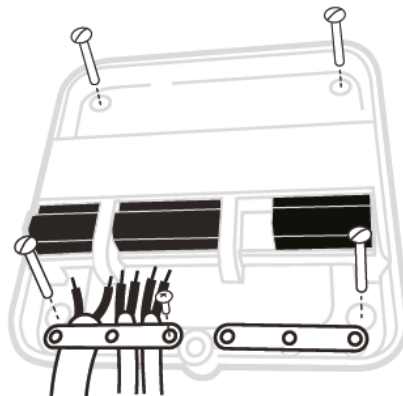

E. Replace cover

Locate the hinges at the top of the cover and wall plate, align the cover and secure with the screw.

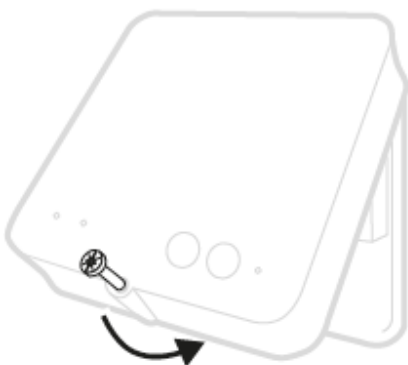

F. Power ON

Turn ON mains power to the 2-channel Receiver box and the Heating Appliance and installation is complete.

None of the LED's will be lit after power up!

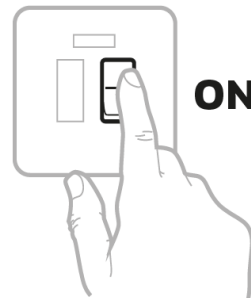

Mounting and wiring T6RWP thermostat

To ensure your safety, **always make sure mains power is switched OFF** before accessing wiring.

Before removing the old thermostat take a picture of the old thermostat's wiring as a reference then proceed to installation.

Needed during installation: Wall box with minimum depth of 40 mm and with 230V cabling (neutral and line)

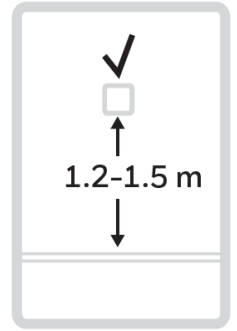
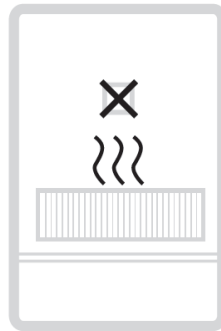
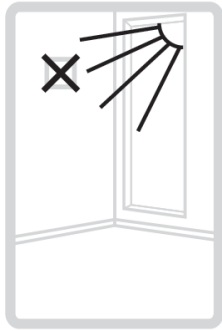
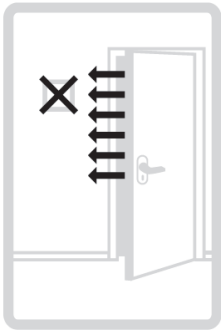

The T6RWP thermostat should not be placed near draughts, in direct sunlight or near heat sources. It should be at least 1.2 - 1.5 meters from the floor.

A. Power off

First make sure the power is turned off!

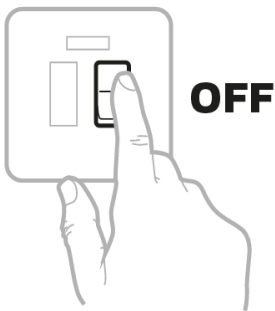

B. Power module

Connect the 230V power wires to the power module.

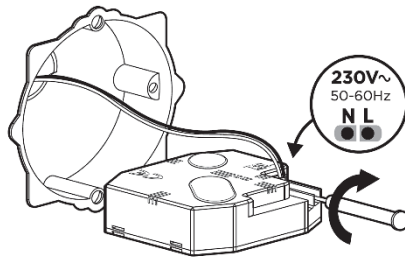

C. Wall plate

Using a screwdriver open wall plate terminal cover to connect wires.

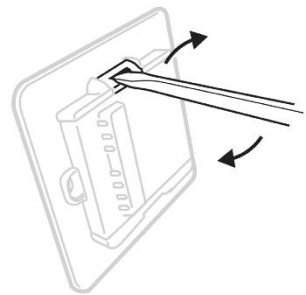

D. Wiring wall plate

Connect thermostat wires to the terminals: **red to +** and **black to -**

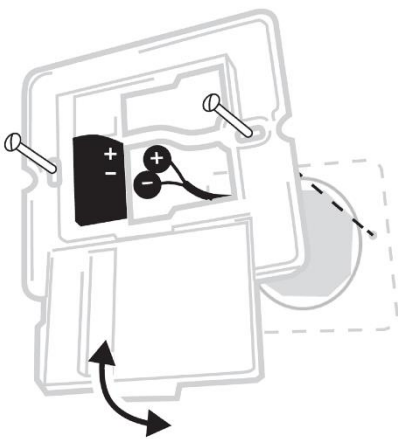

E. Place thermostat

Attach the thermostat to the wall plate when finished.

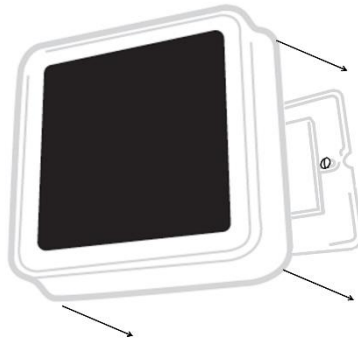

F. Power on

Turn power back on

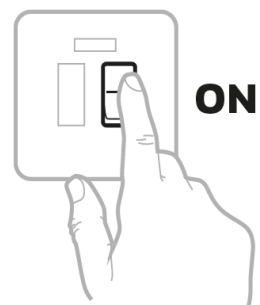

T6RWP Set-up and binding

Zone 1 Thermostat powering up, setup and binding

Both the T6RWP Smart Thermostats still need to be bound to the 2-channel Receiver box before they can control the comfort in their zone.

After powering up the thermostats **SETUP** is displayed on the screen of the thermostats. Follow the next steps to complete set-up and binding, starting with Zone 1:

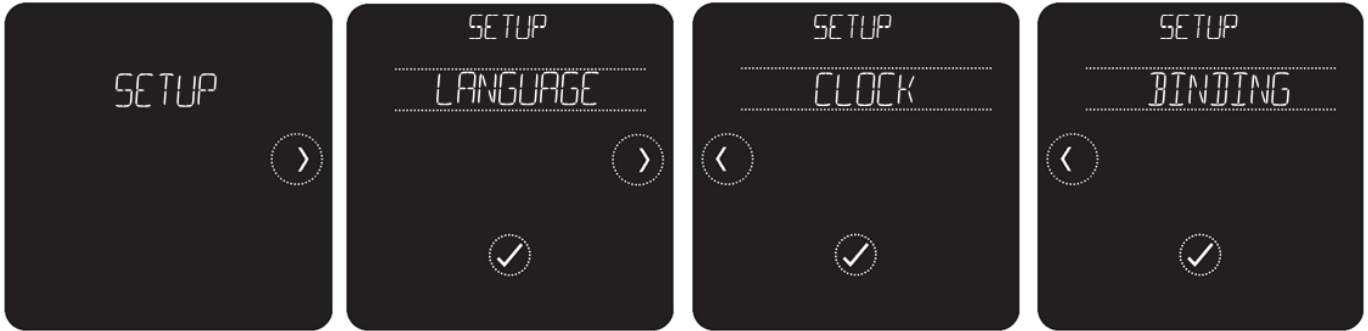

Touch to begin setup.

Select language.

Set clock format, time and date.

Touch to start binding with 2-channel Receiver box.

Next put the 2-channel Receiver box into binding mode by pressing Zone 1 button for 3 sec.

- The first RF LED will flash amber

Note: When the Receiver box has been bound before first press with a small pin the pinhole for approximately 3 seconds to reset the binding. All LED's will flash amber for a moment.

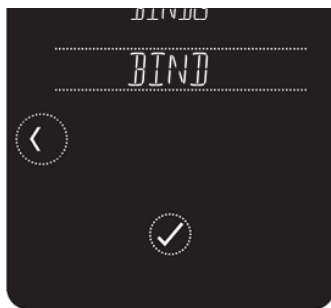
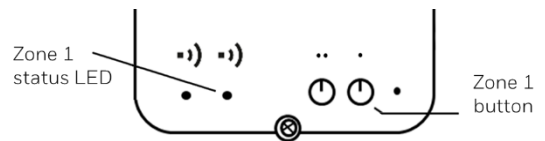

Touch and the signal will be sent.



When binding successful:
- thermostat shows **SUCCESS**
Zone 1 status LED shows green

touch to proceed.



Touch to select system type.

When binding is **NOT** successful:

- Thermostat will show **FAILED**

- Receiver box will exit binding after 3 min.

RF communication might be too far or is blocked due to wrong location of the Thermostat or Receiver box. Try to move closer or re-locate and re-bind again.



Touch to select heat only application



Touch to finalise setup.
(to setup using the Honeywell App is currently unsupported)



Zone 1 thermostat setup and binding is complete. Thermostat is switched OFF

Zone 2 Thermostat powering up, setup and binding

Now place the second zone thermostat near the 2-channel Receiver box and plug-in the adapter. When SETUP is displayed on the screen of the thermostat, follow the next steps:

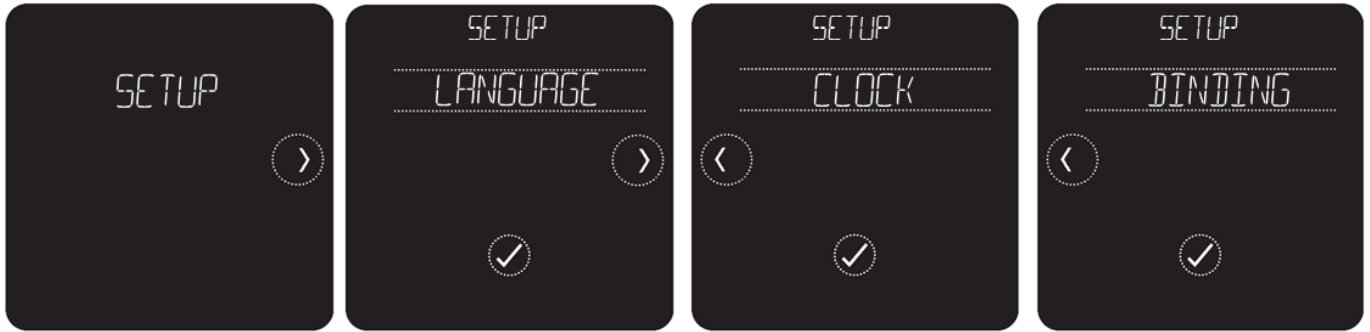

Touch to begin setup.

Select language.

Set clock format, time and date.

Touch to start binding with 2-channel Receiver box.

Next put the 2-channel Receiver box into binding mode by pressing Zone 2 button for 3 sec.
- The first RF LED will flash amber

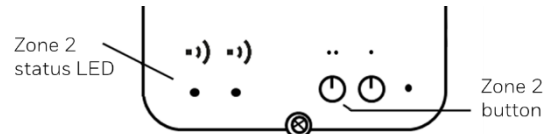

Touch and the signal will be sent.



When binding successful:
- thermostat shows SUCCESS
Zone 2 status LED shows green

touch to proceed.



Touch to select heat only application



Touch to finalise setup.
(to setup using the Honeywell App is currently unsupported)



Zone 2 thermostat setup and binding is complete. Thermostat is switched OFF

After binding the second zone the binding and setup is complete. Place both thermostats on an even and horizontal surface in their appropriate area (zone) to control the comfort.

Note: The thermostats should not be placed near draughts, in direct sunlight or near heat sources. It should be at least 1.2 - 1.5 meters from the floor.



Use the included stickers on the cover of the Receiver box to indicate the application.

Once setup is completed go to the advanced menu to change application specific changes

Advanced menu

To enter the Advanced menu (installer set-up):

Press the  menu key for 5 seconds.

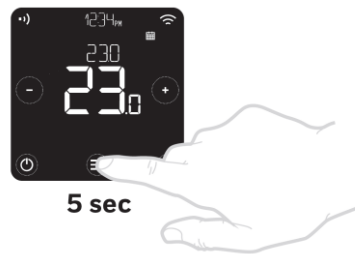

Menu item	Default	Options
Language	English	English, Francais, Espanol, Deutsch, Nederlands, Italiano
System type	Heat + H/W	Heat only, Heat + H/W
OpenTherm	-	OpenTherm boiler data when a available
Cycle rate	6	3,6,9 or 12
Min on time	1 minute	1, 2, 3, 4 or 5 minutes
Heat range	Min = 5.0 Max = 37.0	Min: 5.0°C to 21.0 °C, Max:21.0°C to 37.0 °C
Schedule options	Daily	1 = daily schedule, 2 = 5+2 days schedule
Optimisation	Opt.start on Opt.stop off	Opt start: 0 = off, 1 = on, 2 = Delayed start Opt stop: 0 = off, 1 = on
Clock	Format: 24h Time: --:-- Date: 01/09/2016	Clock format: 1 = 12h, 2 = 24h Setup time and date
Low Load Control	ON	0= Off, 1 = On
Temperature offset	0.0	-1.5°C to 1.5 °C
Bind	-	Bind, check RF and clear bind.
Adv Reset	-	Factory, schedule, Wi-Fi and Homekit reset
Failsafe	OFF	0= Off, 1 = On

Special Features	Description
Heat Range	The normal lower temperature limit of 5°C can be increased up to 21 °C to protect the inhabitants from cold conditions. This is a useful feature aimed at supporting the elderly, children and disabled inhabitants. The normal upper temperature limit of 35 °C can be reduced down to 21 °C to save energy. This feature is useful for leased homes and apartments.
Schedule options	The thermostat has 2 default schedules: daily (every day) and 5+2 (week + weekend days)
Optimisation (optimal start, optimal stop and delayed start)	Optimal Start: learns how long it takes your system to reach the programmed temperature. It turns on the heating system earlier to make sure it's comfortable at the scheduled time. Optimal Stop: Saves energy and money by switching off a little bit earlier than the normal programmed time. If the home is up to temperature, it will not notice the effect on the temperature, but will show a difference in the fuel bill. Delayed start: Saves energy by slightly delaying the start of heating depending on the difference between the scheduled temperature and the actual room temperature
Clock setting	Change display format (default 24hr) and adjust time and date. When connected to Internet time and date will be synchronized
Low Load Control	If the Receiver box is connected to an OpenTherm appliance this setting is used in the demand control. When an appliance is no longer able to modulate lower the control switches from modulating control to low/off control.
Temperature Offset	If the Thermostat is located in a hot/cold location and cannot be moved because of wiring then the measured/ displayed temperature can be adjusted by +/- 1,5°C. This feature is useful if the homeowner wants the reading to match another appliance temperature display.
Binding	Menu to bind the Thermostat and the Receiver box, test the RF signal strength of the radio communication and to clear an existing binding.
Reset	Menu to reset the thermostat back to factory default settings, reset the schedule to default settings, reset the Wi-Fi and Homekit settings.
Failsafe	When the radio communication between the Thermostat and Receiver box is lost for longer than 1 hour the Receiver box will start to cycle the demand 20% on / 80% off.

OpenTherm® communication

OpenTherm® is a manufacturer independent communication protocol between modulating appliances (boilers, air heaters and heat recovery units) and room thermostats.

Via the OpenTherm® protocol, the Receiver box of the T6 / T6R thermostat constantly communicates with the connected appliance.

Modulating

The T6/T6R thermostat controls, via the Receiver box, the OpenTherm® communicating appliance modulating. This means that, depending on the heat demand, the burner capacity is adjusted in the appliance. This creates a very accurate control of the room temperature.

On top of that, this method of temperature control is more energy-efficient and environmentally friendly.

Low Load Control

When a boiler is no longer capable of modulating back it will stop the burner and then will be a cycling on it's own continuously during this low control setting (requested water temperature).

In order to have a proper performance and to switch the pump on/off as well we created low load control. This is cycling between off and min modulation level.

The cycle rate is related to the time the water temperature is cooling off below the control setpoint (demand) and the on time of the boiler to get heated to the control setpoint.

It's an algorithm which optimizes the cycle rate and tries to get the boiler on for the longest time.

Hot water control

Most Combi-boilers have a small internal storage for hot tap water. By keeping a number of liters of hot water, the appliance can supply hot tap water directly without having to heat it up first. With a longer period of none use or absence, for example sleep or holiday, the hot water storage does not have to be kept at a high temperature.

The T6/T6R thermostat can provide additional savings here. With the last programmed period (sleeping) the hot water status can easily be switched to a saving level or completely be switched off.

With these Combi-boilers, a menu "Hot water during sleep" (on/off) will be available in the installer menu (page 6).

OpenTherm® data

De T6/T6R thermostat offers the ability to view some appliance data via de OpenTherm® communicatie.

See table on page 6 which data can be viewed.

Note: Depending on the connected appliance, more or less data is displayed on the T6/T6R thermostat and certain settings of the appliance may or may not be changed from the thermostat. Refer to the instruction manual of the appliance for specific information.

Advanced menu item	Default	Data / Options
OpenTherm	Submenu (read only)	<ul style="list-style-type: none">- Low Load Control- Control Setpoint → Requested supply temperature- Supply Water Temperature → Actual supply water temperature- Return Water Temperature → Actual return water temperature- Max Supply Water Temperature- Hot water Temperature → Actual hot water temperature- Hot Water Setpoint- Actual Power → Actual power of appliance- Water Pressure
Hot Water Overnight	1	0= OFF, 1 = ON
Hot Water Setpoint	60	30 tot 75 °C (appliance depending)
Max Supply Water Setpoint	90	30 tot 90 °C (appliance depending) - future
Low Load Control	1	0= OFF, 1 = ON

Heat demand control

The control of the heat demand of the 2 zones depends on the applied boiler type.

An on/off boiler or an OpenTherm® modulating boiler can be applied.

The 2-channel Receiver box receives from both zone thermostats the heat demand and will control the corresponding zone valve via the relay contact to open.

For the cycle rate setting recommend the standard setting 6x per hour.

When an on/off boiler is applied, it can only be controlled on/off by means of the zone valve end switches

For an OpenTherm® boiler, use the OpenTherm® connection on the 2-channel Receiver box.

ON/OFF controlled boiler

The boiler will be switched on when one of the zone valves is completely opened and the end switch switches. When both end switches are not switched, the boiler is off.

The cycle rate setting determines also the cycle rate of the boiler.

There is no synchronization of the heat demand of the 2 zone thermostats, which could cause the boiler to switch off (end demand of a zone) and almost instantly switch on again by the demand of the other zone.

Some boilers have an anti-cycle time, which prevents them from switching on directly again.

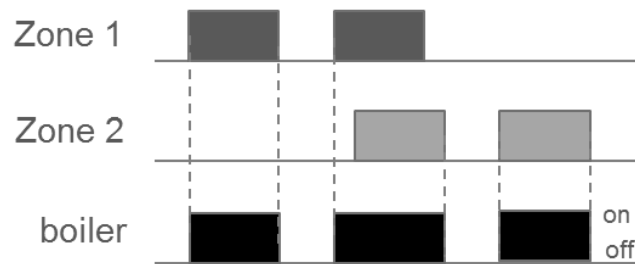

OpenTherm® controlled boiler

When one of the zone thermostats communicates a demand the OpenTherm® will also be receiving a heat demand. When both zones no longer require heat the demand is taken away and the boiler will switch off.

The 2-channel Receiver box constantly compares the demand of both zones and communicates the highest demand to the OpenTherm® boiler.

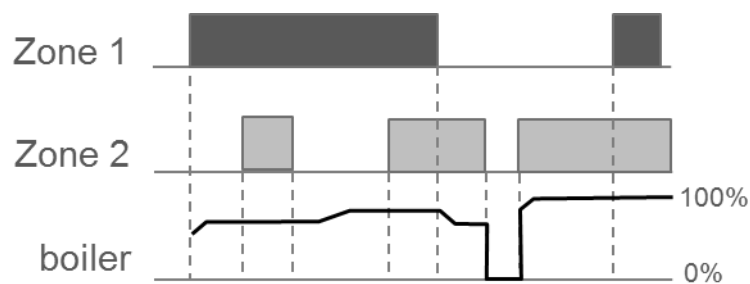

Technical Specifications

T6RWP Thermostat

Control form	: Adaptive Fuzzy Logic
Room Temperature display range	: From 0°C to 50°C
Dimensions (w x h x d)	: T6RWP (wireless) 103 x 103 x 68 mm
Time display	: 24 hour or 12 hour AM/PM format
Time keeping accuracy	: Synchronized with Internet when connected or typically better than 10 minutes per year
Program Heating	: 5+2 or daily schedule with 6 daily time and temperature level changes
Program Hot water	: 5+2 or daily schedule with 3 ON periods per day
Time setting resolution	: Program - 10 minute steps
Sensing element	: 100K (@ 25°C) NTC thermistor
Temperature setting range	: Program : 5 to 37°C in 0.5 °C steps OFF : 5°C
Power	: 5VDC

RF communication

RF operation band	: ISM (868.0-868.6) MHz, 1% duty cycle
Max. power	: 25mW
Protocol	: Encrypted
Comm. Range	: 30 m in a residential building environment
Comm. technology	: short, high rate transmissions to minimise air time and avoid collisions
Receiver class R.E.D.	: RX Cat 2 (ETSI EN300 220-1 version 1.3.1)
RF binding method	: Factory pre-bound
Wi-Fi	: IEEE 802.11b/g/n – 2.4GHz
Max. power	: 100mW

ACC900 In-wall power module

Power	: 230VAC
Output	5VDC Max. 650mA
Wiring (230V)	: Terminal block capable of accepting wires up to 1.5 mm ²
Wiring (5VDC)	: 10 cm cable with 2 wires.
Dimensions	49 x 52 x 27 mm (w x h x d)
IP class	: 30

Receiver box

Power	: 230VAC
Electrical rating	: 230 V~, 50...60 Hz, 0.5 A to 5 A resistive
Relay contacts	0.5 A to 3 A inductive (0.6 pf) 24 V~, 50...60 Hz, 0.5 A to 5 A resistive 0.5 A to 3 A inductive (0.6 pf)
Cycle rate	: Selectable by application (see installer set up)
Wiring	: Terminal block capable of accepting wires up to 1.5 mm ²
Wire access	: From back via large wall box opening. From bottom with cable clamps. Mains wiring – left. Low voltage wiring – right.
Dimensions	: 110 x 110 x 40 mm (w x h x d)
IP class	: 30

Environmental and standards

Operating temperature range	: 0 to 40°C
Shipping and storage temperature	: -20 to 55°C
Humidity range	: 10 to 90% rh, non-condensing
Receiver Category 2	: 868.3MHz
Max RF Power	: 25 mW
Operating frequency	: 868–868.6MHz
Wi-Fi	: 2.4GHz
Max Power	: 100mW
Operating frequency	: 2.4–2.458GHz
ErP	: Class V (+3%), (EU) 811/2013
<p>Hereby, Pittway Sarl declares that that the radio equipment type T6H700RW is in compliance with Directive 2014/53/EU. The full text of the EU declaration of conformity is available at the following internet address: https://hwllhome.co/DoC</p>	

Trouble Shooting

Symptom (Fault message)	Possible Cause	Remedy
The Receiver box button LED is green but the heat or hot water does not switch on.	Heat or hot water wiring might be incorrect or broken	Check the Receiver box wiring
The status LED on the Receiver box is red (Communication loss)	The Receiver box receives no communication from the thermostat: RF communication might be too far or is blocked due to Receiver box location. Thermostat is no longer powered.	Try to move thermostat or Receiver box closer or re-locate. Check the power to the thermostat
Thermostat alert messages		
WIFI RADIO ERROR	The Wi-Fi radio of thermostat is faulty.	Replace thermostat
INTERNAL MEMORY ERROR	The internal memory of thermostat is faulty.	Replace thermostat
INDOOR TEMPERATURE SENSOR ERROR	(wired only) The external temperature sensor is not connected or the wiring is faulty.	Check external sensor wiring and sensor
NO COMMUNICATION RECEIVER BOX	The thermostat receives no communication from the thermostat: RF signal is blocked due to the location of the thermostat. Receiver box is no longer powered.	RF communication might be too far or is blocked due to the location of the Thermostat or Receiver box. Check the power to the Receiver box
RF SIGNAL OF RECEIVER BOX LOW	There is a weak radio signal from the Receiver box	Try to move thermostat or Receiver box closer or re-locate.
NO RECEIVER BOX	The thermostat is not bound with the Receiver box	Bind or re-bind the Receiver box
NO INTERNET	Thermostat has no longer Internet connection.	End user needs to check their Internet connection via router.
NO WIFI SIGNAL	Thermostat has no longer a Wi-Fi connection.	End user needs to check their Wi-Fi network of router.
REGISTER ONLINE	Thermostat is connected to Internet but not yet registered to an account.	End user needs to download the App, create an account and register the thermostat.
WIFI NOT CONFIGURED	Thermostat is not connected to Wi-Fi network.	End user needs to download the App, create an account, connect and register the thermostat.
BOILER FAILURE FAULT XX	The OpenTherm boiler reported a failure number XX.	Check the boiler
BOILER LOW WATER PRESSURE	The boiler reported low water pressure.	Fill up the hydronic system with water.

Ordering specification

Description	Model	EAN code	Literature
T6R Wireless Smart Thermostat (spare)	T6H700RW4011	5025121381161	http://hwllhome.co/eut-T6
2-channel Receiver box R6 wireless (spare)	R6H911RF4018	5025121381130	

For more information:
Phone: 0300 130 1299

200 Berkshire Place
Winnersh Triangle,
Berkshire RG41 5R



resideo

Pittway Sarl, Z.A. La Pièce 4,
1180 Rolle, Switzerland

www.resideo.com

© 2023 Resideo Technologies, Inc. All rights reserved.
The Honeywell Home trademark is used under license from
Honeywell International Inc.
This product is manufactured by Resideo and its affiliates.

T6RWP-2Z-EN0H 8612 NL01 0423