

Condensing Unit Technical Data Sheet

Model CMPT14RA_N
Voltage 220-240V 50Hz ~1
Refrigerant R404A

APPLICATION

Application	High Back Pressure
Refrigerant	R404A
Evaporating Temp.	-15,0 °C to 10,0 °C
Expansion	Capillar/Valve
Comp. Cooling	Fan cooled
Max. ambient temp.	43,0 °C

COMPRESSOR

Displacement	14,32 cm ³
Diameter	29,37 mm
Stroke	21,13 mm
Oil type	ISO VG 32 ESTER
Oil charge	400 cm ³

MOTOR

Nominal Power	1/2 hp
Voltage/Frequency	220-240V 50Hz
Voltage range	198-255 V
Type	CSR
Phase number	1 PH
Locked Rotor Amps (LRA)	21,00 A
Max. Cont. Current (MCC)	6,50 A
Main W. resist. at 25°C	4,50 Ω
Start W. resist. at 25°C	5,75 Ω

NOMINAL PERFORMANCE

Cooling Capacity	2.306 W
COP	2,38 W/W
EER	2,05 kCal/Wh
Input Power	967 W
Current	3,94 A

ASHRAE

TEST CYCLE CONDITIONS

	HBP
Evaporating temp. (T _e)	7,2 °C
Condensing temp. (T _c)	55,0 °C
Liquid temp. (T _{liq.})	46,0 °C
Ambient temp. (T _{amb.})	35,0 °C
Suction temp. (T _{suction})	35,0 °C
Voltage/Frequency	220 V 50 Hz

CONDENSER AND FAN DATA

Condenser type	CU-AL
Condenser model	12T 3R
Fan blade (Ø mm / °)	300 / 25
Fan motor	25W 220-240V 50/60Hz

WIRING DIAGRAM

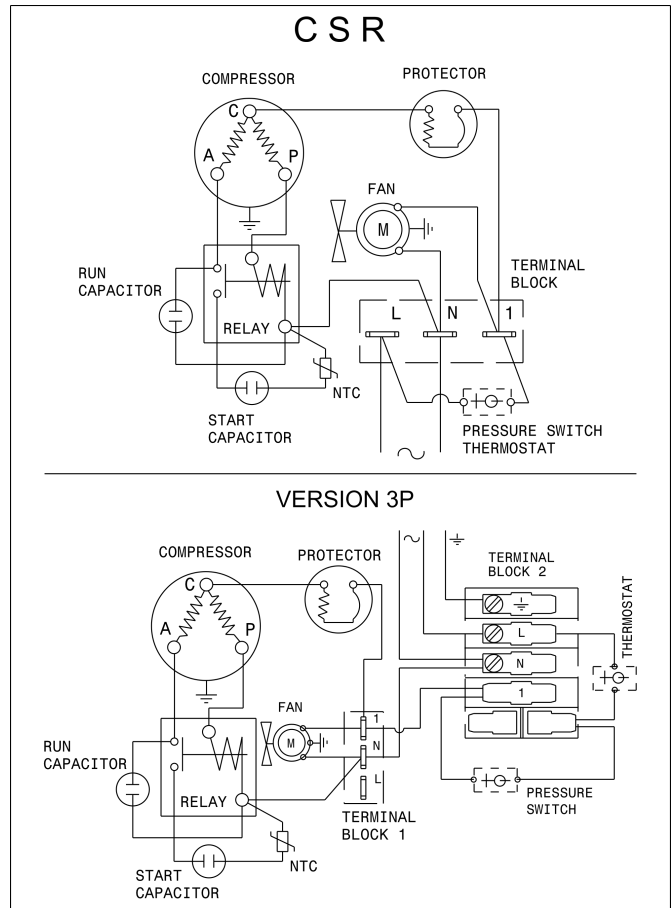

REFRIGERATION CAPACITY (W) Evaporating Temperature (°C)

Model	Motor	-25	-15	-5	5	7.2			10
						W	Winp	A	
CMPT14RA_N	CSR	702	1080	1563	2161	2306	967	3.94	2501

ASHRAE HBP: Condensing temperature: 55°C, Liquid temperature: 46°C, Suction temperature: 35°C, Ambient temperature: 35°C

Condensing Unit Technical Data Sheet

VERSIONS

VERSION 1	VERSION 2	VERSION 3	VERSION 3P	VERSION 4
Tube	Service valve	Service valve and receiver	Service valve, receiver, pressure switch	Schrader valve on the service port
Suction tube internal diam.: 8,1 mm Discharge tube internal diam.: 6,5 mm Net Weight: 27,7 Kg	Suction valve: 3/8" Discharge valve: 3/8" Net Weight: 28,1 Kg	Receiver vol.: 2,4 l Suction valve: 3/8" Discharge valve: 3/8" Net Weight: 29,9 Kg	Receiver vol.: 2,4 l Suction valve: 3/8" Discharge valve: 3/8" Net Weight: 31,0 Kg	Suction tube internal diam.: 8,1 mm Discharge tube internal diam.: 6,5 mm Net Weight: 27,7 Kg

DIMENSIONS (Version 3 drawing)

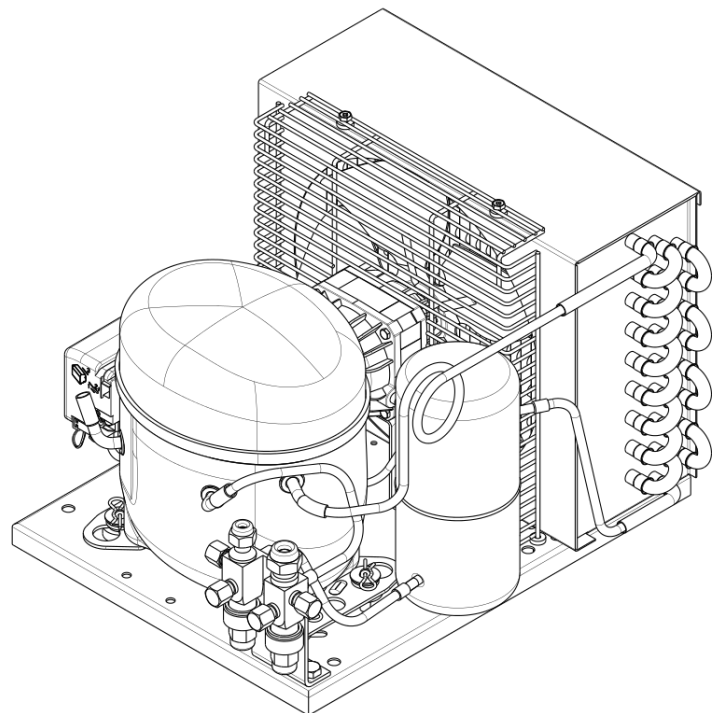
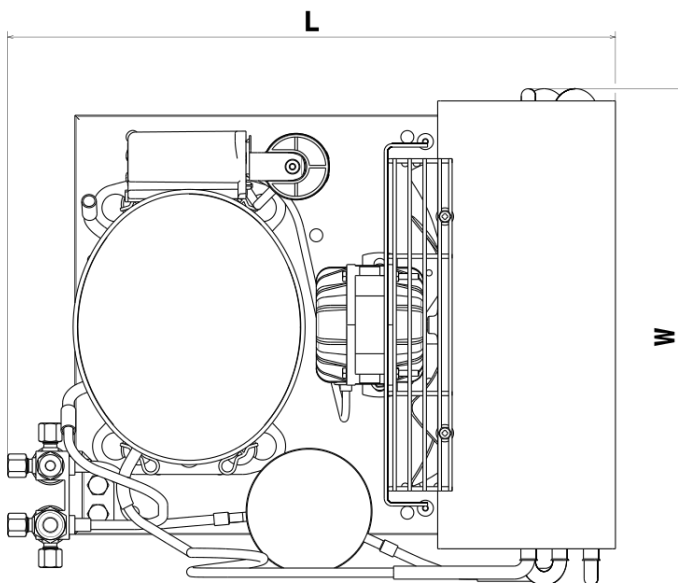
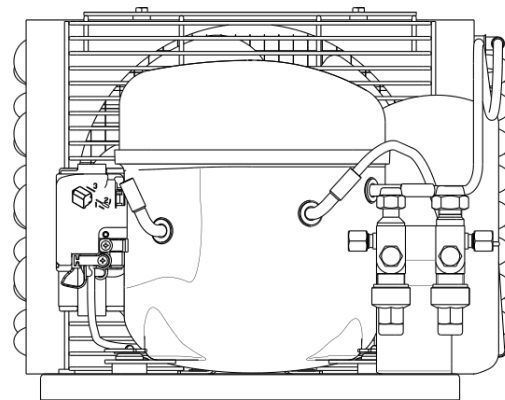
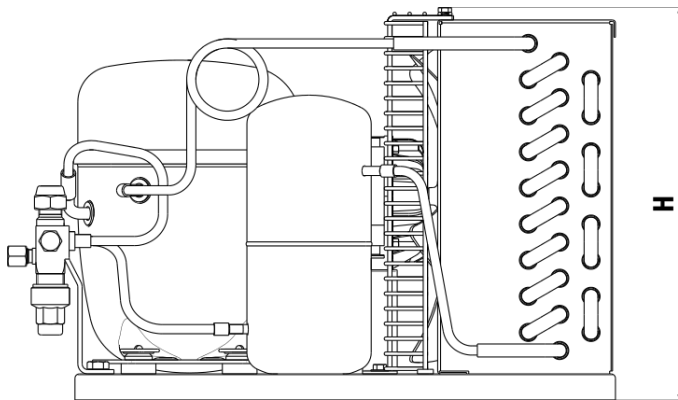

VERSION 1-4 (WxLxH) (mm)	VERSION 2 (WxLxH) (mm)	VERSION 3 (WxLxH) (mm)	VERSION 3P (WxLxH) (mm)
430x500x350	430x520x350	435x520x350	435x530x350