



Series	Type	Vin	Vout [kV]	Iout cc [mA]	ED	Output	Applications	page
--------	------	-----	-----------	--------------	----	--------	--------------	------



TRS INDUCTIVE TRANSFORMER | TRASFORMATORE INDUTTIVO TRS

TRS513C	230V	2x2,5	10	100%	Grounded center			•	•	28
TRS812C	230V	2x4	12	100%	Grounded center		•		•	28
TRS815C	230V	2x4	15	100%	Grounded center				•	28
TRS818C	230V	2x4	18	100%	Grounded center		•		•	28
TRS820	230V	2x4	20	25% on 4'	Grounded center		•			28
TRS1020	230V	2x5	20	25% on 4'	Grounded center		•			28
TRS1020	230V	2x5	20	33% on 3'	Grounded center		•		•	28
TRS1030	230V	2x5	30	25% on 4'	Grounded center		•			28
TRS1220	230V	2x6	20	25% on 4'	Grounded center		•			28
TRS404PC	230V	1x4	4	100%	Grounded pole	•	•			29
TRS505PC	230V	1x5	5	100%	Grounded pole	•	•			29
TRS508PC	230V	1x5	8	100%	Grounded pole	•	•			29
TRS510PC	230V	1x5	10	100%	Grounded pole	•	•			29
TRS515PC	230V	1x5	15	100%	Grounded pole	•	•			29
TRS6.508PC	230V	1x6,5	8	100%	Grounded pole	•	•			29
TRS606PC	230V	1x6,5	6	100%	Grounded pole	•	•			29
TRS610PC	230V	1x6,5	10	100%	Grounded pole	•	•			29
TRS708PC	230V	1x7	8	100%	Grounded pole	•	•			29
TRS818PC	230V	1x8	18	100%	Grounded pole	•	•			29
TRS820P	230V	1x8	20	25% on 4'	Grounded pole	•	•			29
TRS723P US	120V	1x7	23	25% on 4'	Grounded pole	•	•			29
TRS820PISO	230V	1x8	20	33% on 3'	Insulated	•	•			29
TRS830P	230V	1x8	30	25% on 4'	Grounded pole	•	•			29
TRS1815C/IS	230V	1x2	15	100%	Insulated	•	•			29



TRS



28

2 POLES | 2 POLI

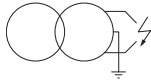

Technical drawing | Disegno tecnico [mm]

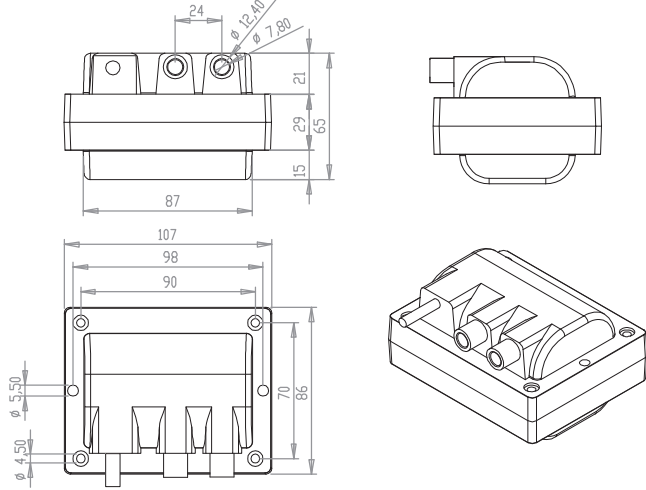

Inlet | Ingressi

Standard buried cable
Cavo annegato standard

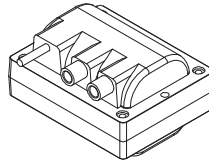

COFI plug
Presca per spina Cofi

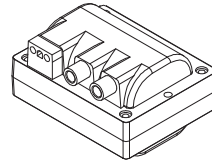

Triangle plug
Presca spina Triangolo

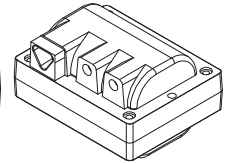

Outlet | Uscite

Cod: SPRO

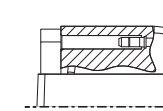

Cod: VIRAS

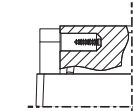

Cod: SPRAS

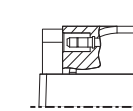

Cod: SPMAN

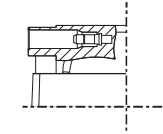

Cod: SP

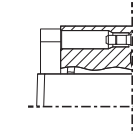

Cod: VIMAN

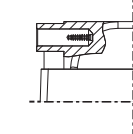

Type	Vin	Freq	Vout	Iout	ED	Output	Note
CONTINUOUS 100% CONTINUI 100%							
TRS513C	230V	50Hz	2x2,5 kV	10 mA	100%	Grounded center	CE
TRS810C	230V	50Hz	2x4 kV	10 mA	100%	Grounded center	DVE CE
TRS812C	230V	50Hz	2x4 kV	12 mA	100%	Grounded center	DVE CE
TRS815C	230V	50Hz	2x4 kV	15 mA	100%	Grounded center	CE
TRS818C	230V	50Hz	2x4 kV	18 mA	100%	Grounded center	CE

INTERMITTENT | INTERMITTENTI

TRS820	230V	50Hz	2x4 kV	20 mA	25% on 4'	Grounded center	DVE CE
TRS1020	230V	50Hz	2x5 kV	20 mA	25% on 4'	Grounded center	DVE CE
TRS1020	230V	50Hz	2x5 kV	20 mA	33% on 3'	Grounded center	DVE CE
TRS1030	230V	50Hz	2x5 kV	30 mA	25% on 4'	Grounded center	CE
TRS1220	230V	50Hz	2x6 kV	20 mA	25% on 4'	Grounded center	CE

Applications | Applicazioni



Available certification | Certificazioni disponibili

