

Valvole 3 vie deviatrici laterali

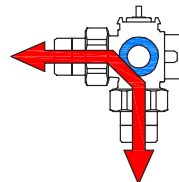

DIAMETRO	1/2"	3/4"	1"	3/4	1"	1" 1/4	1/2"	3/4"	1"
CODICE	233BL	203BL	213BL	203ML	213ML	223ML	233FBL	203FBL	213FBL
DN	15	15	20	15	15	20	15	15	20
PN	16								
KV (m³/h)	10,3 / 3,5	10,3 / 3,5	18 / 4,2	10,3 / 3,5	10,3 / 3,5	18 / 4,2	10,3 / 3,5	10,3 / 3,5	18 / 4,2

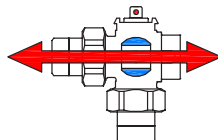
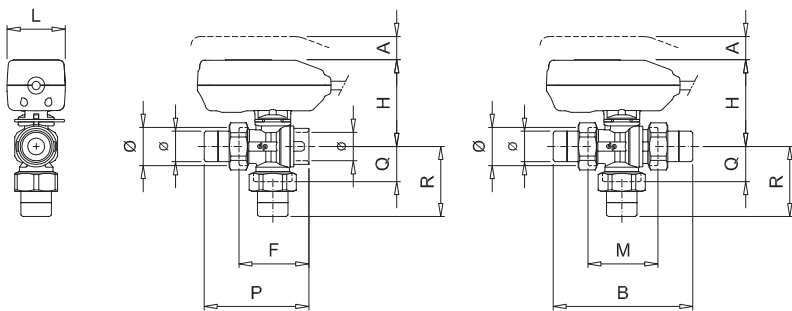

Ø F&B	Ø M	H	A min.	M	B	Q	R	F	P	L
1/2"	3/4	75	20	59	113	29	56	59	86	50
3/4"	1"			60	120	30	60	60	90	
1"	1"1/4	78		72	141	35	70	72	107	

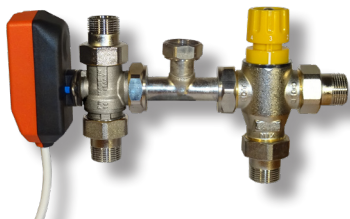
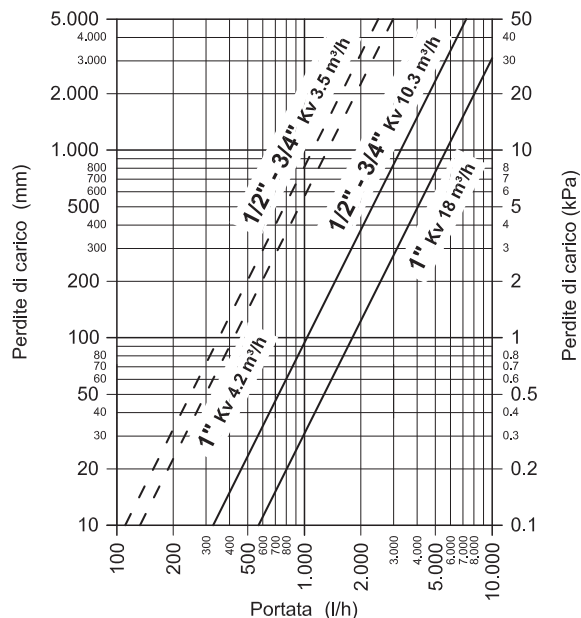

Kit di integrazione impianto solare - caldaia motorizzato per produzione ACS

ALIMENTAZIONE	Ø	Kv	CODICE
230 Vac	3/4"	2,7 m ³ /h	KSCM-S



Centralina digitale cod. CS1CN con sonda inclusa

Servomotori

I servomotori comprendono un riduttore con **ingranaggi in acciaio** trattato termicamente e vengono proposti con l'intenzione di offrire con un solo prodotto, la compatibilità con tutte le valvole della serie FAST

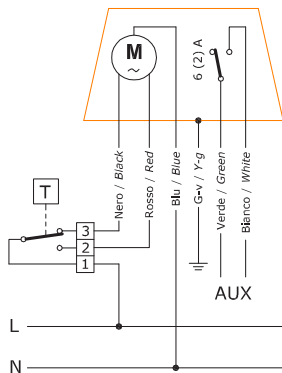

BIDIREZIONALI

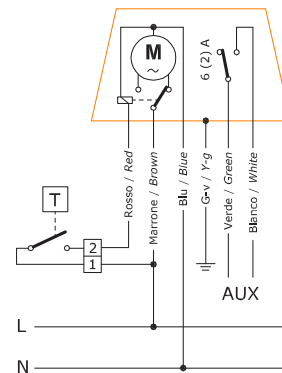
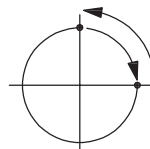

CARATTERISTICHE SERVOMOTORE				
	M2B	M2C	R2B	R2C
TIPO DI COMANDO	3 FILI		2 FILI (RELE' INCORPORATO)	
ALIMENTAZIONE	230 V - 50 Hz	24 V - 50 Hz	230 V - 50 Hz	24 V - 50 Hz
ASSORBIMENTO	4 W			
CONTATTO AUSILIARIO	MAX 6 (2) A - 250 V			
TEMPO DI MANOVRA	12" X 90°			
TEMPERATURA AMBIENTE DI LAVORO	0 ÷ 65 °C			
GRADO DI PROTEZIONE ELETTRICO	IP 54			
CAVO DI COMANDO	6 X 0,5 mm ² - 1 metro			

I servomotori con comando a 3 fili **NON** possono essere collegati in parallelo ad unico termostato/controllo

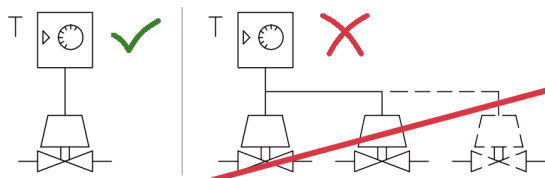

Servomotori con comando a 3 fili (cavo bianco)



I servomotori con comando a 2 fili possono essere collegati in parallelo ad unico termostato/controllo

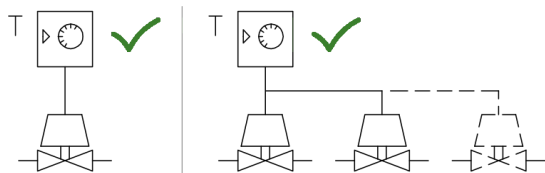

Servomotori con comando a 2 fili (cavo grigio)



CONTATTO AUSILIARIO

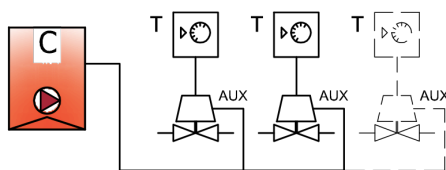

I contatti ausiliari di più servomotori possono essere collegati in parallelo alla caldaia. Il primo contatto che chiude aziona la caldaia. L'ultimo contatto che apre spegne la caldaia

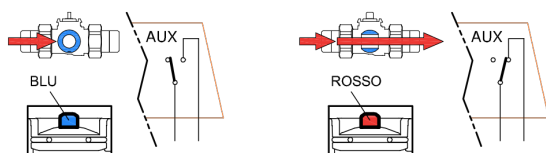

Il contatto ausiliario chiude a valvola aperta (indicatore servomotore rosso)