



Frost Protection Thermostat

RAK-TW.5..H
RAK-TW.5..H..

Electromechanical thermal reset limit thermostat

-
- **Monitoring of frost protection temperature, with single-pole changeover microswitch**
 - **Switching capacity:** contact connection 1-2: 16 (2.5) A, AC 250 V
contact connection 1-3: 6 (2.5) A, AC 250 V
 - **Time constant conforming to DIN EN 14597**
 - **3 mounting choices: pipe, air duct (with perforated pocket) or wall mounting**
 - **Adjusted limit temperature can be checked through the viewing window in the housing**
 - **IP43 und IP65 protection class available**
 - **Push-in terminals for fast installation**

Use

Typical applications:

- Heat generation plant
- For general use in heating, ventilation and air conditioning plant
- Frost protection

Function

Changeover switch
(S.P.D.T.)

When the adjusted limit temperature is reached on falling temperature (frost protection function), contact connection 1-3 changes over to contact connection 1-2. When the temperature of the medium rises by the value of the switching differential, the frost protection thermostat reverts to contact connection 1-3.

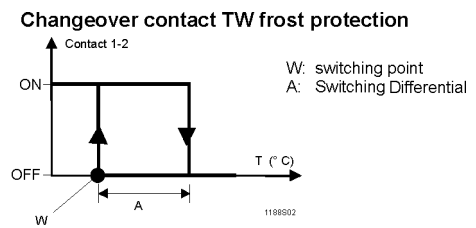

If the probe has cooled down to a temperature below approx. -20°C , the control current circuit opens, however, automatically closes again, when the temperature rises

Type summary

Product No.	Stock number	Degree of protection	Temperature setting range	Capillary tube length	Scope of delivery
RAK-TW.5000HS	S55700-P120	IP65	5...65 °C	1600 mm	Clamping band for max. pipe dia. 100 mm, cable gland M16x1.5 mm, mounting instructions
RAK-TW.5000S-H	S55700-P121	IP43	5...65 °C	1600 mm	
RAK-TW.5010S-H	S55700-P122	IP43	-10...50 °C	1600 mm	

Accessories

The pockets must be ordered as a separate item.
(refer to Data Sheets N1193 and N1194).

Ordering

When ordering, please give type reference according to "Type summary" (standard set).





If the accessories required are not those included in the standard set, they can be ordered separately according to the type references given in Data Sheets N1193 and N1194.

Mechanical design

Housing

- The base of the thermostat is made of PC (reinforced) and is designed for pipe, pocket or wall mounting; the electromechanical frost protection thermostat uses a capillary type sensing element.
- The cover is made of PC and has a viewing window.
- The cable gland is M16x1.5 mm.
- The PC plastic is especially designed to be flame resistant, UV protected and flexible against high temperatures and tough against chemical and biological impacts.

Notes

Mounting aid	Installation Instructions are enclosed in the package.
Mounting location	It must be ensured that there is sufficient clearance above the thermostat for seeing through the viewing window, for adjusting the limit temperature and for removing and replacing the thermostat, if required.
Pipe mounting	The clamping band should be properly tightened to ensure the entire length of the sensing element is in close contact with the pipe's surface.
Pocket mounting in air duct	Install the perforated pocket, immerse the capillary sensing element with the coupling spring in it and secure the base to the pocket by means of the screw.
Wall mounting with sensing element in the pocket	To prepare for wall mounting, knock out the fixing holes in the housing and pull out the capillary tube until the required length is reached. After immersing the capillary sensing element in the perforated pocket (refer to pocket mounting), secure it with a clamp (mounting accessories).
 Temperature setting	The limit temperature must be adjusted only by qualified personnel.
 Wiring	The appliance must be wired by the installer only. Line insulation must always be sufficient for available rated voltage. Wire the thermostat according to the connection diagram and in compliance with local regulations.
 Max. AC 250 V	Caution: prior to opening the housing, disconnect the thermostat from the mains supply.
 	Earth connections must be made in compliance with the regulations.

Disposal



The device is considered electrical and electronic equipment for disposal in terms of the applicable European Directive and may not be disposed of as domestic garbage.

- Dispose of the device via the channels provided for this purpose.
- Comply with all local and currently applicable laws and regulations.

Technical data

Switching mechanism	Switching capacity		
	Nominal voltage	AC 24...250 V	
	Nominal current $I_{(M)}$	contact connection 1-2	0.1...16 (2.5) A
		contact connection 1-3	0.1... 6 (2.5) A
	External fuse	16 A	
	Life expectancy at nominal rating	min. 100 000 switching cycles	
	Safety class	I to EN 60 730	
	Degree of protection:	IP43 and IP65 to EN 60 529	
	Temperature setting range	(with tool)	
		RAK-TW.5000HS	
	RAK-TW.5000S-H	5... 65 °C	
	RAK-TW.5010S-H	-10...50 °C	
	Thermal switching differential	5 K	
Directives and Standards	Product standard	EN 60730-x DIN EN 14597 (TW1197) ¹⁾	
	EU Conformity (CE)	CE1T1206xx ¹⁾	
	Radio interference protection	click rate $N \leq 5$ to EN 55 014	
Environmental conditions	Operation	class 3K5 to IEC 60 721-3-3	
	Max. temperature on bulb	max. switching temperature + 25 K	
	Ambient temperature at the housing	max. 80 °C (T80)	
	Humidity	< 95 % r.h.	
	Mechanism	class 3M2 to IEC 60 721-3-3	
	Storage and transport	class 2K3 to IEC 60 721-3-2	
	Ambient temperature	-25...+70 °C	
	Humidity	< 95 % r.h.	
	Max. temperature socket	125 °C	
	Degree of pollution	2 to EN 60 730	
Calibration	Controlled medium	Water, air, oil	
	Calibration temperature	30 °C	
	Manufacturing deviation	± 3 °C for RAK-TW.5010S-H	
	Calibrated for ambient temperature at the switching mechanism and capillary tube	0 °C / -6 °C for RAK-TW.5000S-H RAK-TW.5000HS 22 °C to DIN EN 14597	
	Time constant in: water	<45 s to DIN EN 14597	
	oil	<60 s to DIN EN 14597	
	air	<120 s to DIN EN 14597	
	Connections	Electrical connections	Push In ²⁾ terminals for wires 6 x 0.75...2.5 mm ²
		Earth connection	Push In ²⁾ terminals for wires 2 x 0.75...2.5 mm ²
		Cable gland	M16 x 1.5 mm
External wiring flexible cord		designed to be connected with unprepared conductors or prepared conductors, e.g. ferrules	
Environmental compatibility	The product environmental declaration CE1E1186de ¹⁾ contains data on environmentally compatible product design and assessments (RoHS compliance, materials composition, packaging, environmental benefit, disposal).		

General data

Housing colors	base RAL 7001 (dark-grey) cover RAL 7035 (light-grey)
Dimensions of sensing element	6.5 mm dia. x 78 mm
Capillary length	1 600 mm
Min. bending radius of capillary	R min. = 5 mm
Construction	
Carrier of switching mechanism	plastic
Capillary tube and sensing element	copper
Diaphragm	stainless steel
Weight of standard set	0.35 kg

1) The documents can be downloaded from <http://siemens.com/bt/download>.

2) Push In is a patented connection technology designed by Weidmüller, Germany's leading manufacturer of electrical connection technologies.

Connection diagram

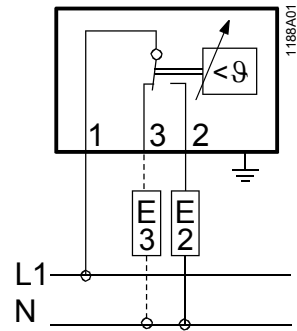

For frost protection function, contact connection 1 – 2 closes

Dimensions

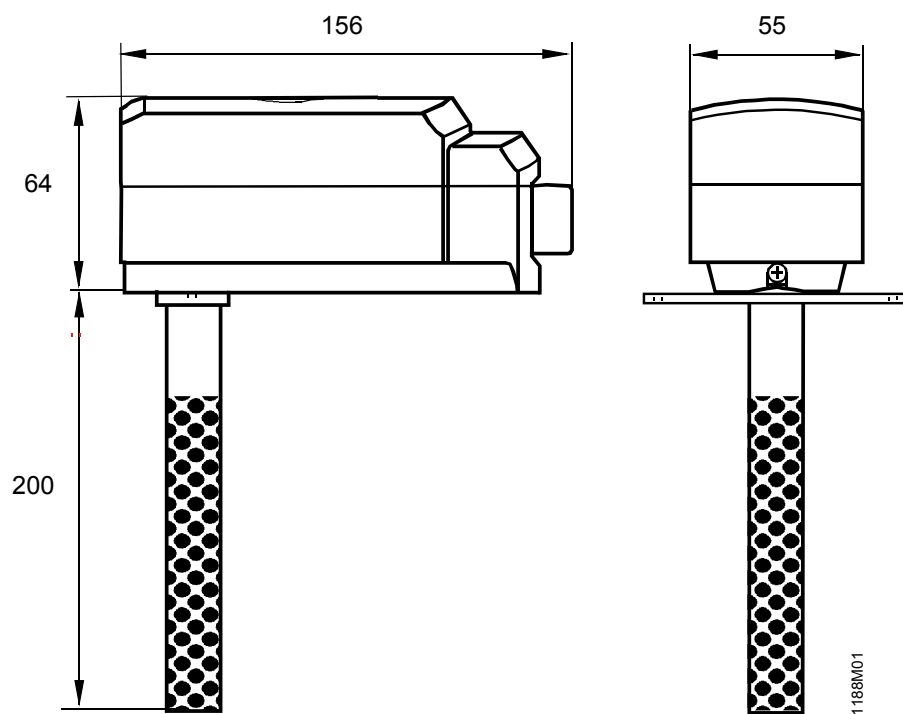

Published by:
Siemens Switzerland Ltd.
Building Technologies Division
International Headquarters
Theilerstrasse 1a
6300 Zug
Switzerland
Tel. +41 58-724 24 24
www.siemens.com/buildingtechnologies

© Siemens Switzerland Ltd 2005
Delivery and technical specifications subject to change