

Boccole cilindriche a strascinamento

Composizione=acciaio/bronzo sinterizzato/ PTFE

Art.PLTBOC121412AC

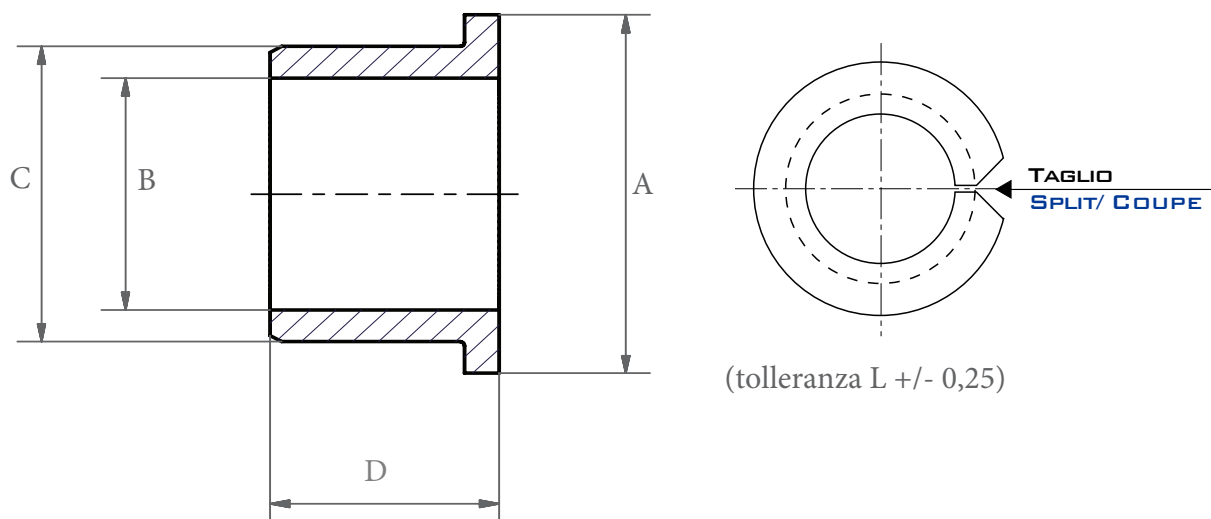

Tabella dimensionale boccole PTFE

Codice	A	Ø B	C	D
PLTBOC121412AC	20	12	14	12