



## Electromotoric Actuators

## SFA21/18

## SFA71/18

for zone valves

- **SFA21/18** AC 230 V operating voltage, 2-position control signal
- **SFA71/18** AC 24 V operating voltage, 2-position control signal
- **Positioning force 200 N**
- **Spring return**
- **Manual adjustment**
- **For direct mounting with union nut (no tools required)**
- **Integral 1.8 m connecting cable**
- **Auxiliary switch, type ASC2.1/18 (optional)**

### Use

- For Siemens zone valves V..I46..
- Primarily in heating, ventilation, air conditioning and refrigeration systems for water-based control of low-temperature hot water and cooling water.

## Type summary

Type	Operating voltage	Positioning time	Positioning signal	Connecting cable
SFA21/18	AC 230 V	10 s	2-position	1.8 m
SFA71/18	AC 24 V			

## Accessories

Type	Description	Switching point	Switching capacity	Connecting cable
ASC2.1/18	Auxiliary switch	at approx. 50 % stroke	AC 250 V / 3(2) A	1.8 m

## Ordering

When ordering please specify the quantity, product name and type code.

Example 2 electric actuators, type SFA71/18 and  
2 auxiliary switches, type ASC2.1/18

## Delivery

Actuators, valves and accessories are supplied separately.

## Equipment combinations

### Zone valves

Type reference	Valve type	k <sub>vs</sub> [m <sup>3</sup> /h]	PN class	DN	Data sheet
VVI46..	2-port valves, internal thread Rp	2.0...5.0	PN16	15...25	N4842
VXI46.. <sup>1)</sup>	3-port valves, internal thread Rp				

<sup>1)</sup> 3-port valve with tight bypass order separately: VXI46.25T with SFA.. electromotoric actuator, for details see datasheet N4842

k<sub>vs</sub> = Nominal flow rate of cold water (5...30 °C) through the fully open valve (H<sub>100</sub>) by a differential pressure of 100 kPa (1 bar)

## Thermostats

Type	Compatible thermostats for SFA21/18 and SFA71/18
RAA..	RAA10; RAA20; RAB30..; RAA40
RAB..	RAB10; RAB10.1; RAB20; RAB20.1; RAB30; RAB30.1; RAB40.1
RCC..	RCC10; RCC20; RCC20.1; RCC30
RDX..	RDX42.2
RDF..	RDF10; RDF10.1; RDF10.2; RDF20; RDF30, RDF110, RDF210
RDE..	RDE10; RDE10.1; RDE20.1
RDD..	RDD10; RDD10.1
RCU..	RCU10; RCU10.1

## Technical design / mechanical design

The electric actuator requires an on/off controller (thermostat) to control the valve. If the temperature of the medium deviates from the setpoint, the controller output signal causes the actuator to drive the valve open. When the temperature of the medium reaches the setpoint, the control signal is cut off and the valve closes again.

The valve is opened electrically by the actuator and closed by spring force. It incorporates a synchronous motor, a gear mechanism and a return spring. The electric motor is overload-resistant and anti-locking, so that continuous operation is possible. The maximum stroke is limited mechanically. The closing motion, by contrast, includes an overrun for the gear mechanism. This protects the gear mechanism from mechanical shock and increases service life.

The valve is connected by an 1.8 m cable, which is an integral part of the actuator.

## Accessories

---

### Auxiliary switch ASC2.1/18

The optional auxiliary switch can be fitted to the actuator with two screws.

It switches at a stroke of approx. 50 %.

0 ... 50 % : Q11 → Q12 closed

Q11 → Q14 open

50 % ... 1 : Q11 → Q12 open

Q11 → Q14 closed

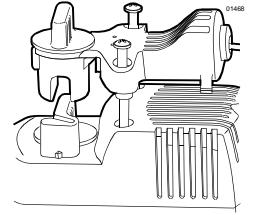

See «Technical data» on page 5 for further information on the auxiliary switch.

## Engineering notes

---

The admissible temperatures (see «Technical data», page 5) must be observed.

### Electrical connection

The actuator may be operated only with alternating current (AC 230 V for SFA21/18 and AC 24 V for SFA71/18).

#### **Caution**

- **Phase cut and pulse-duration-modulated signals are not suitable.**
- Recommended number of opening/closing operations: approx. 50 per day, with 200 heating or cooling days.

## Mounting notes

---

Mounting instructions 74 319 0407 0 are enclosed with the packaging. Mount AL50 supporting ring on valve V..46.. beforehand.

#### **Caution**

Do not encase actuator with heat insulation.

### Orientation

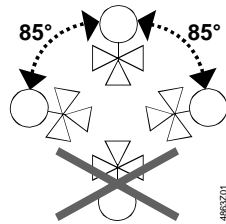

**Commissioning notes**

- Check the wiring.
- Check the functioning of the actuator and of the auxiliary switch, if fitted.

**Manual adjustment**

The valve can be opened manually by use of a lever on the actuator. When the valve is approximately 90 % open the lever locks into position. When electrical operation is resumed, the locking mechanism is released automatically.

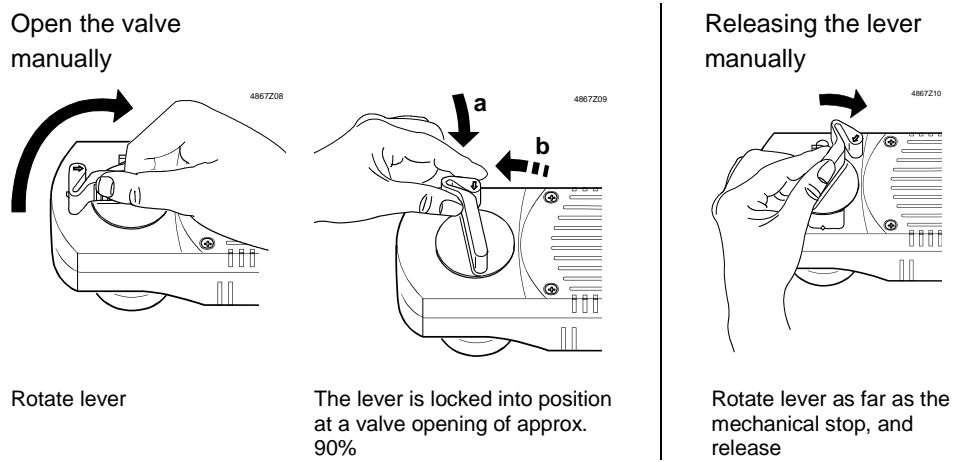

**Maintenance**

The actuators require no maintenance.

They cannot be repaired. In the event of a fault, the actuator can be replaced without removing the valve.

**Caution** ⚠

The operating voltage must be switched off during this process.

**Disposal**

	<p><b>⚠ WARNING</b></p>
	<p><b>Tensioned return spring</b></p> <p>Opening the actuator housing can release the tensioned return spring resulting in flying parts that may cause injury.</p> <ul style="list-style-type: none"> <li>• Do not open the actuator body.</li> </ul>

	<p>The device is considered electrical and electronic equipment for disposal in terms of the applicable European Directive and may not be disposed of as domestic garbage.</p> <ul style="list-style-type: none"> <li>• Dispose of the device through channels provided for this purpose.</li> <li>• Comply with all local and currently applicable laws and regulations.</li> </ul>
--	--

**Warranty**

The technical data given for these applications is valid only when the valves are used with the actuators described under «Equipment combinations». Page 2.

**The use of type SFA.. actuators with third-party valves invalidates any warranty offered by Siemens Switzerland Ltd / HVAC Products.**

## Technical data

		SFA21/18	SFA71/18
<b>Power supply</b>	Operating voltage	AC 230 V	AC 24 V
	Voltage tolerance	± 15 %	± 20 %
	Frequency	50 / 60 Hz	50 / 60 Hz
	Power consumption	12 VA	
	Primary fuse	Max. 3A (external)	
<b>Control</b>	Positioning signal	2-position <sup>1)</sup>	
	Parallel operation of several actuators	permitted <sup>2)</sup>	
	Opening / closing operations	recommended number: approx. 10'000 / year (equivalent to approx. 50 / day)	
<b>Operating data</b>	Position with de-energized actuator		
	2-port valve (VVI46..)	A → AB closed	
	3-port valve (VXI46..)	AB → A closed	
	Positioning time (opening / closing)	10 s (at 50 Hz)	
	Nominal stroke	2.5 mm	
	Positioning force	200 N	
	Admissible temperature of medium in the connected valve	1...110 °C	
	Manual adjustment	0...90 %	
<b>Electrical connection</b>	Connecting cable (integral)	2-core, 1.8 mm / 18 AWG (0.96 mm <sup>2</sup> )	
<b>Norms and standards</b>	Meets requirements for CE marking:		
	EMC directive	89/336/EEC	
	Immunity	EN 61000-6-2	Industrial <sup>2)</sup>
	Emission	EN 61000-6-3	Residential
	Low voltage directive	73/23/EEC	
	Electrical safety	EN 60730-1	
	Product standards for automatic electrical controls	EN 60730-2-14	
	Protection class to EN 60730	II	III
	Contamination level	EN 60730, Class 2	
	Housing protection	IP30 to DIN 40050, EN 60529	
Upright to 85 ° horizontal, do not suspend			
Environmental compatibility	ISO 14001 (Environment) ISO 9001 (Quality) SN 36350 (Environmentally compatible products) RL 2002/95/EG (RoHS)		
<b>Mounting</b>	Fixing on valve	union nut M30 x 1,5	
<b>Dimensions / weight</b>	Dimensions	refer to « Dimensions », page 7	
	Weight without auxiliary switch	0.585 kg	
	with auxiliary switch	0.692 kg	
<b>Materials</b>	Base plate	die-cast aluminium	
	Housing	PBT	
	Union nut	brass, nickel plated mat	
<b>Housing colors</b>	Base and cover	light gray RAL7035	
	Lever	pigeon blue RAL5014	
<b>Auxiliary switch (optional)</b>	Switching type	changeover contact	
	Switching point	at approx. 50 % stroke	
	Switching capacity	AC 250 V, 3 A resistive, 2 A inductive	
	Connecting cable	3-core, 1.8 mm 18 AWG (0.96 mm <sup>2</sup> )	

<sup>1)</sup> Phase cut and pulse-duration-modulated signals are not suitable.

<sup>2)</sup> Consider controller's power output

## General ambient conditions

	Operation	Transport	Storage
	EN 60721-3-3	EN 60721-3-2	EN 60721-3-2
Environmental conditions	Class 3K3	Class 2K3	Class 2K3
Temperature	1...50 °C	-25...70 °C	-25...70 °C
Humidity	5...85 % r. h.	< 95 % r. h.	< 95 % r. h.

## Connecting cable

### SFA21/18 actuator

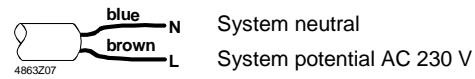

### SFA71/18 actuator

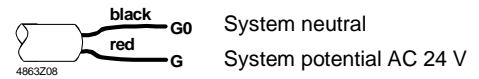

### ASC2.1/18 auxiliary switch

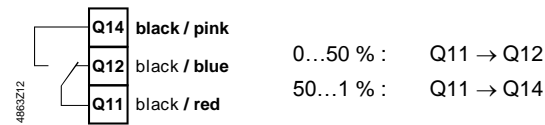

## Connection diagrams

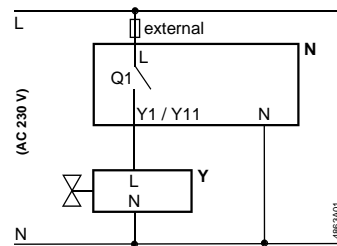

N controller (thermostat)  
Y actuator with zone valve  
L system potential AC 230 V  
N system neutral  
Y1 control signal OPEN  
Q1 controller contact

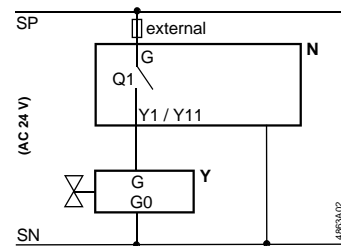

N controller (thermostat)  
Y actuator with zone valve  
G system potential AC 24 V (SP)  
G0 system neutral(SN)  
Y1 control signal OPEN  
Q1 controller contact

## Dimensions

Dimensions in mm

**Actuator without  
auxiliary switch**  
SFA21/18, SFA71/18

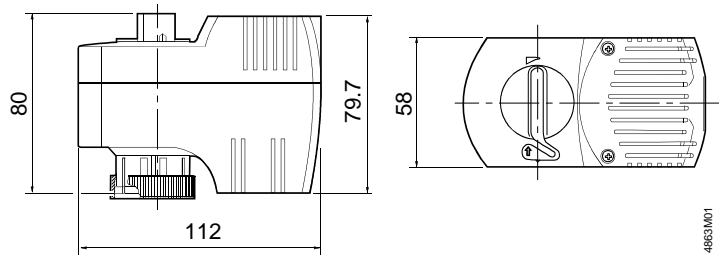

**Actuator with  
auxiliary switch**  
SFA21/18, SFA71/18  
with ASC2.1/18

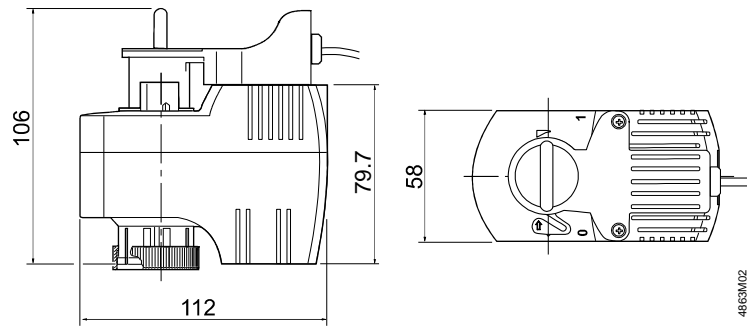

Issued by  
Siemens Switzerland Ltd  
Smart Infrastructure  
Global Headquarters  
Theilerstrasse 1a  
6300 Zug  
Switzerland  
Tel. +41 58-724 24 24  
[www.siemens.com/buildingtechnologies](http://www.siemens.com/buildingtechnologies)

© Siemens Switzerland Ltd, 2019  
Technical specifications and availability subject to change without notice.