

ELECTRONIC TRANSFORMERS

TRASFORMATORI
ELETTRONICI



10

Series	Type	Vin	Iout cc mA	ED	Output	Applications	page
--------	------	-----	------------------	----	--------	--------------	------



TRK ELECTRONIC TRANSFORMERS | TRASFORMATORE ELETTRONICO TRK



TRK1-20CVD	220-240V	20	100%	Grounded center		•	•	14
TRK1-20PCVD	220-240V	20	100%	Grounded pole	•		•	15
TRK1-30CVD	220-240V	30	100%	Grounded center		•	•	14
TRK1-30CHD	220-240V	30	100%	Grounded center		•	•	18
TRK1-30PCVD	220-240V	30	100%	Grounded pole	•		•	15
TRK2-35	220-240V	35	33% on 3'	Grounded center		•		14
TRK2-30PVD	220-240V	30	33% on 3'	Grounded pole	•			15
TRK2-30PFVD	220-240V	30	33% on 3'	Grounded pole	•			15
TRK2-30PVDUS	220-240V	30	33% on 3'	Grounded pole	•			15
TRK2-30PFVDUS	220-240V	30	33% on 3'	Grounded pole	•			15
TRK2-30PHD	220-240V	30	33% on 3'	Grounded pole	•			18
TRK2-40VD	220-240V	40	33% on 3'	Grounded center		•		14
TRK2-40HD	220-240V	40	33% on 3'	Grounded center		•		18
TRK2-40HK	220-240V	40	33% on 3'	Grounded center		•		16
TRK2-40HKL	220-240V	40	33% on 3'	Grounded center		•		16
TRK2-40PVD	220-240V	40	33% on 3'	Grounded pole	•			15
TRK2-40PHK	220-240V	40	33% on 3'	Grounded pole	•			17
TRK2-40PHKL	220-240V	40	33% on 3'	Grounded pole	•			17
TRK2-40SHK	220-240V	40	33% on 3'	Insulated		•		16
TRK2-40SVD	220-240V	40	33% on 3'	Insulated		•		14
TRK2-40PHD	220-240V	40	33% on 3'	Grounded center		•		18
TRK1-20CUVD	120V	20	100%	Grounded center		•		14
TRK1-20PCUVD	120V	20	100%	Grounded pole	•			15
TRK2-30PUVD	120V	26	33% on 3'	Grounded pole	•			15
TRK2-30PUFVD	120V	26	33% on 3'	Grounded pole	•			15
TRK2-30UVD	120V	30	33% on 3'	Grounded center		•		14

TRJ ELECTRONIC TRANSFORMER | TRASFORMATORE ELETTRONICO TRJ



TRJ2-30VD	220-240V	21	33% su 3'	Grounded center		•		19
TRJ2-30PVD	220-240V	20	33% su 3'	Grounded pole	•			19
TRJ3-40CVD	220-240V	30	100%	Grounded center		•	•	20

TRS



28

2 POLES | 2 POLI

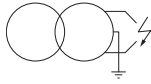

Technical drawing | Disegno tecnico [mm]

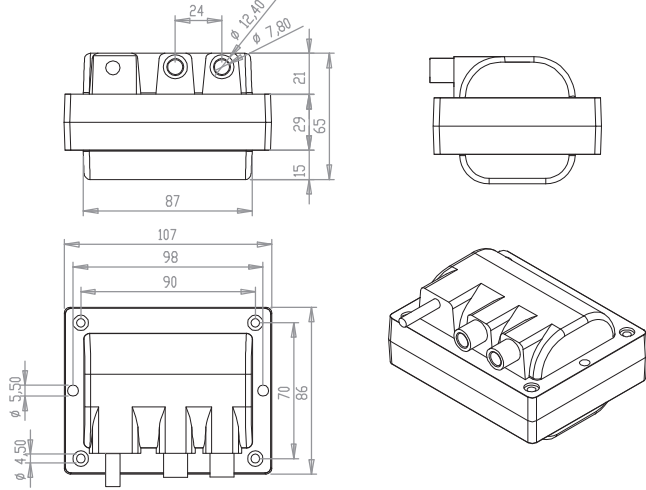

Inlet | Ingressi

Standard buried cable
Cavo annegato standard

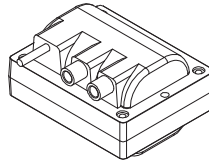

COFI plug
Presca per spina Cofi

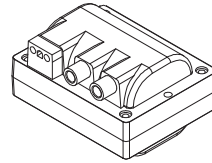

Triangle plug
Presca spina Triangolo

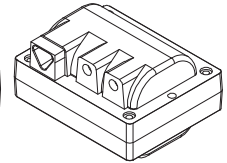

Outlet | Uscite

Cod: SPRO

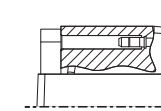

Cod: VIRAS

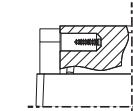

Cod: SPRAS

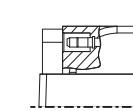

Cod: SPMAN

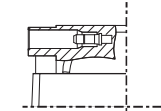

Cod: SP

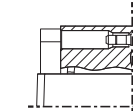

Cod: VIMAN

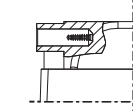

Type	Vin	Freq	Vout	Iout	ED	Output	Note
CONTINUOUS 100% CONTINUI 100%							
TRS513C	230V	50Hz	2x2,5 kV	10 mA	100%	Grounded center	CE
TRS810C	230V	50Hz	2x4 kV	10 mA	100%	Grounded center	DVE CE
TRS812C	230V	50Hz	2x4 kV	12 mA	100%	Grounded center	DVE CE
TRS815C	230V	50Hz	2x4 kV	15 mA	100%	Grounded center	CE
TRS818C	230V	50Hz	2x4 kV	18 mA	100%	Grounded center	CE

INTERMITTENT | INTERMITTENTI

TRS820	230V	50Hz	2x4 kV	20 mA	25% on 4'	Grounded center	DVE CE
TRS1020	230V	50Hz	2x5 kV	20 mA	25% on 4'	Grounded center	DVE CE
TRS1020	230V	50Hz	2x5 kV	20 mA	33% on 3'	Grounded center	DVE CE
TRS1030	230V	50Hz	2x5 kV	30 mA	25% on 4'	Grounded center	CE
TRS1220	230V	50Hz	2x6 kV	20 mA	25% on 4'	Grounded center	CE

Applications | Applicazioni



Available certification | Certificazioni disponibili

