

Self-learning Room Temperature Controller

RAV11...

with analogue 24-hour or weekly time switch



Mains-independent room temperature controller featuring straightforward operation.

Self-learning two-position controller providing PID control (patented).

Freely selectable switching times.

Use

Room temperature control in:

- Single-family and holiday houses
- Apartments and office spaces
- Individual rooms and consulting rooms
- Commercially used spaces

For the control of the following pieces of equipment:

- Solenoid valves of instantaneous water heaters
- Solenoid valves of atmospheric gas burners
- Forced draught gas and oil burners
- Circulating pumps in heating systems
- Electric direct heating
- Fans of electric storage heaters
- Zone valves (normally closed))

Functions

- PID control
- Self-learning or selectable switching cycle
- Freely adjustable 24-hour mode
- Freely adjustable weekly mode with weekly time switch
- Frost protection function
- Minimum limitation of set point

Type summary

Room temperature controller, DC 3 V battery powered without time switch	RAV11
Room temperature controller, DC 3 V battery powered with analogue 24-hour time switch	RAV11.1
Room temperature controller, DC 3 V battery powered with analogue weekly time switch	RAV11.7
Analogue 24-hour time switch	AUZ3.1
Analogue weekly time switch	AUZ3.7

Ordering

When ordering, please give type reference according to "Type summary".

Delivery

The unit is supplied with batteries.

Mechanical design

Plastic casing with analogue 24-hour or weekly time switch, easily accessible operating elements and removable cover. The removable battery compartment allows straightforward replacement of the two 1.5 V alkaline batteries. The base plate can be fitted to all commercially available recessed conduit boxes or directly on the wall and can then be wired before fitting the controller to it. The casing accommodates the electronics with the DIP switch. The potential-free changeover contact and the connection terminals are located on the base plate.

Operating elements

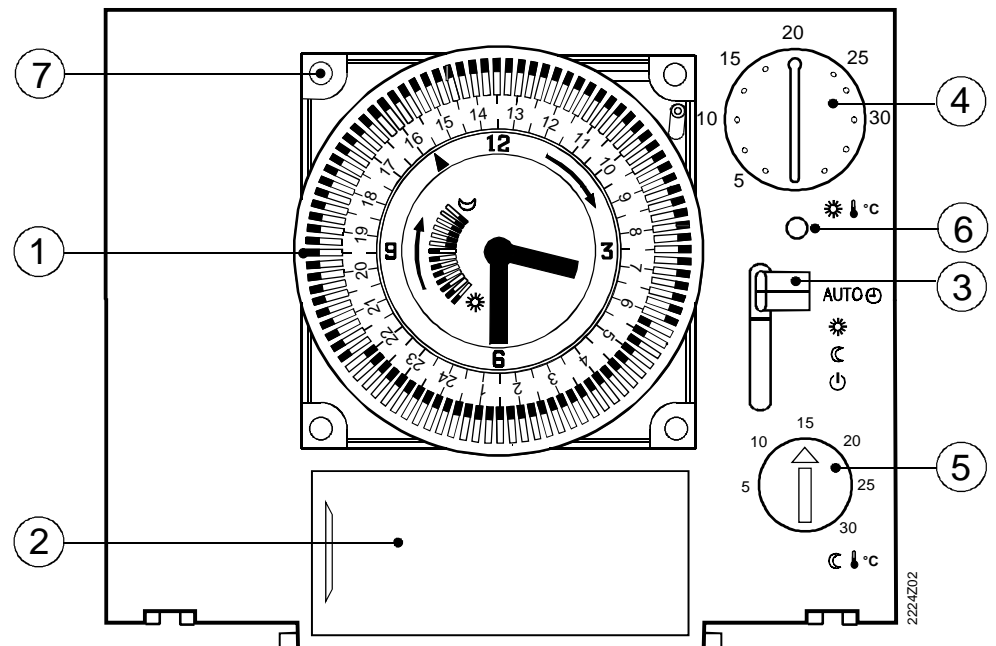

- ① **Analogue time switch**
 - ☀ Tappets tilted **outward** for **normal** temperature
 - ☾ Tappets tilted **inward** for **economy** temperature
- ② **Battery compartment**
 - Two alkaline batteries 1.5 V (AA)
- ③ **Operating mode selector**
 - AUTO ⏻ Heating periods according to tappet settings on time switch
- ④ **Setting knob for normal temperature**
- ⑤ **Setting knob for economy temperature**
- ⑥ **LED for low battery indication**
- ⑦ **Position for time switch**

- ☀ Continuous normal temperature
- ☾ Continuous economy temperature
- ⏻ Standby with frost protection

Operating modes

- AUTO ⏻ Heating periods according to tappet settings on time switch
- ☀ Continuous normal temperature
- ☾ Continuous economy temperature
- ⏻ Standby with frost protection

Set points

	Factory settings	Setting range
☀	20 °C	5...30 °C
☾	15 °C	5...30 °C

Technical features

DIP-Switch

	1	2	3	4
Self learning	<input type="checkbox"/>	<input type="checkbox"/>		
PID 12	<input type="checkbox"/>	<input type="checkbox"/>		
PID 6	<input type="checkbox"/>	<input type="checkbox"/>		
2-Pt 	<input type="checkbox"/>	<input type="checkbox"/>		

2224Z01

Control

The RAV11... is a two-position controller providing PID control. The room temperature is controlled through the cyclic switching of a regulating unit.

Self-learning mode

The controller is supplied with an active self-learning mode, which enables it to automatically adapt to the controlled system (type of building construction, type of radiators, size of rooms, etc.). After a certain learning period, the controller optimises its parameters and then operates in the mode it has learned.

In exceptional cases, where the self-learning mode may not be adequate, it is possible to choose between PID 12, PID 6 or 2-Pt mode:

PID 12 mode

Switching cycle of 12 min for normal or slow controlled systems (e.g. massive building structures, large spaces, cast-iron radiators, oil burners).



PID 6 mode

Switching cycle of 6 min for fast controlled systems (e.g. light building structures, small spaces, plate radiators or convectors, gas burners).

2-Pt mode

Pure two-position control with a switching differential of 0.5 °C (± 0.25 °C) for very difficult controlled systems with considerable outside temperature variations.

Setting knobs

		
Standard	5...30 °C	5...30 °C
Version 1 *	20 °C	15 °C
Version 2 *	18...22 °C	13...17 °C
Version 3 *	15...25 °C	10...20 °C



* at request

Analogue time switches

The unit has an opening for fitting a plug-in type switch.

If desired, the time switch fitted can be replaced by another. The electrical connections to the controller are established via a terminal strip so that no wiring is required. *The time switches can only be mounted in one position.*

The analogue time switches are equipped with a quartz clock. The switching dial is equipped with tappets that can be tilted. The heating periods are entered by tilting the tappets within the required period of time:

- Tappets tilted outward: Normal temperature 
- Tappets tilted inward: Economy temperature 

24-hour time switch	Weekly time switch
The 24-hour time switch has a 24-hour switching dial. It carries 96 tappets, which means four tappets per hour, giving a resolution of 15 minutes. The shortest possible heating period also is 15 minutes.	The weekly time switch has a 7-day switching dial. It carries 84 pairs of tappets, which means 12 pairs of tappets or 24 individual tappets per day. The resolution is thus one hour. However, since - for mechanical reasons - at least two tappets need to be tilted together to set one heating period, the shortest possible heating period is two hours.

Calibration of detector

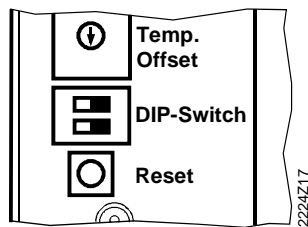



If the measured room temperature does not agree with the temperature set on the knob, the temperature detector can be recalibrated.

This can be done by adjusting a potentiometer that is located on the rear of the unit. First, the unit must be removed from the socket.

The possible settings on the potentiometer are:



 (°C)	 (°C)	 Pos.	
22.00	20.00	8	
21.75	20.00	7	
21.50	20.00	6	
21.25	20.00	5	
21.00	20.00	4	
20.75	20.00	3	
20.50	20.00	2	
20.25	20.00	1	
20.00	20.00	0	<= Factory setting
19.75	20.00	F	
19.50	20.00	E	
19.25	20.00	D	
19.00	20.00	C	
18.75	20.00	B	
18.50	20.00	A	
18.25	20.00	9	

After the corrections are made, the new setting must be confirmed by pressing the reset button. **Otherwise the previous settings are still active!** After the reset the controller can be remounted to the socket.

Technical Data

Operating voltage	DC 3 V	Set point for frost protection	5 °C
Batteries (alkaline AA)	2 x 1.5 V	Insulation class	
Battery life (approx.)	2.5 years	to EN 60730-1	II
Backup for battery change	1 min max.	Degree of protection	
		to EN 60529	IP30
CE conformity to		Electromagnetic compatibility	
EEC directive	89/336/EEC	Immunity	EN 50082-2
low voltage directive	73/23/EEC	Emissions	EN 50081-1
Switching capacity of relays		Perm. ambient temperature	
Voltage	AC 24...250 V	Operation	3...35 °C
Current	8 (3.5) A	Storage	-25...+60 °C
Measuring element NTC 68 kΩ at 25 °C		Perm. ambient humidity	
Measuring range	0...40 °C	to DIN 40040	G
Time constant	2 min max.	Weight	0.2 kg
Set point setting range		Colour	White
Normal temperature	3...29 °C		RAL9003
Economy temperature	3...29 °C		
Resolution of analogue time switches			
24-hour time switch	15 min		
Weekly time switch	60 min		

Notes

Engineering

- The room temperature controller should be fitted in the main living room.
- The place of installation should be chosen so that the sensor can capture the room temperature as accurately as possible, without being affected by direct solar radiation or other heating or cooling sources.
- Mounting height is approx. 1.5 m above the floor.
- The unit can be fitted to most commercially available recessed conduit boxes or directly on the wall.

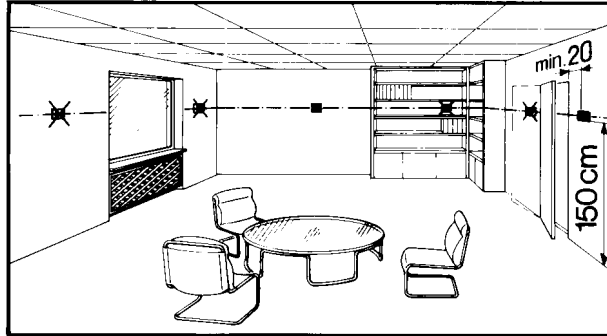

Fitting and installation

- When installing the room temperature controller, the base plate must first be fitted and wired. Then, the unit is engaged at the top, swung downward and secured with two screws.
- For more detailed information, please refer to the installation instructions supplied with the controller.
- For the electrical installation, the local safety regulations and standards must be complied with.

Commissioning

- The battery transit tab, which prevents inadvertent operation of the unit during transport and storage, must be removed from the batteries.
- The control characteristics can be changed with the help of the DIP switches located at the rear of the unit. For detailed information, please refer to the commissioning instructions.
- If the reference room is equipped with thermostatic radiator valves, they must be set to their fully open position.
- If the measured room temperature does not agree with the set room temperature on the setting knob, the detector should be recalibrated (please refer to "Calibration of detector").

Connection diagram

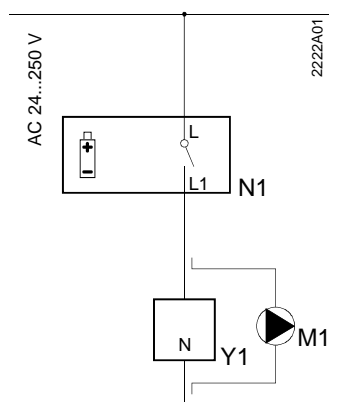

L	Live, AC 24...250 V
L1	N.O. contact, AC 24...250 V / 8 (3.5) A
N	Zero

M1	Circulating pump
N1	RAV11.. controller
Y1	Regulating unit

Application examples

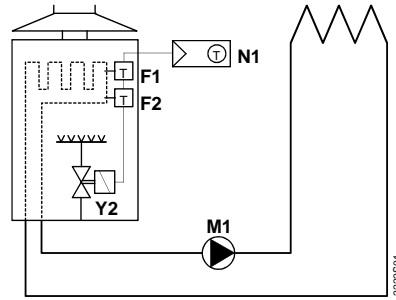

Instantaneous water heater

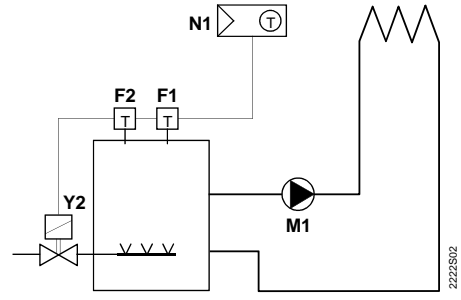

Atmospheric gas burner

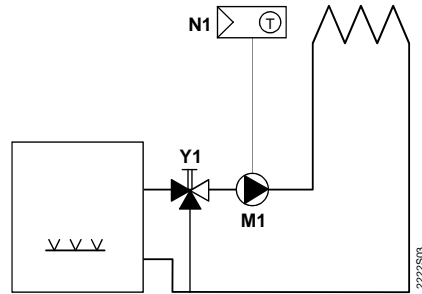

Circulating pump with pre-control by manual mixing valve

F1	Thermal reset limit thermostat	N1	RAV11.. room temperature controller
F2	Manual reset safety limit thermostat	Y1	Manually operated three-port valve
M1	Circulating pump	Y2	Solenoid valve

Dimensions

