

Synco™ 200

Universal Controllers

RLU2...

-
- With programmed standard applications
 - Freely programmable controller, for optimum adaptation to the relevant type of plant
 - P-, PI, or PID mode
 - Menu-driven operation

Use

For use on basic to complex ventilation, air conditioning and chilled water plant. The universal controllers are designed to handle the following controlled variables: Temperature, relative/absolute humidity, pressure/differential pressure, airflow, indoor air quality and enthalpy.

Functions

Operating modes

- Selection of operating mode via status inputs: Comfort, Economy, Protection
- Display of current operating mode (Comfort, Economy, Protection)

Setpoints

- With each sequence controller: Individually adjustable heating and cooling setpoints (or maximum and minimum setpoints) for the Comfort and Economy modes
- Predefined room temperature setpoint with room unit or setpoint readjuster (passive)
- With each sequence controller: Predefined setpoint with remote setpoint adjuster (active or passive)
- Room temperature setpoint with summer and/or winter compensation
- With each sequence controller: Setpoint shift depending on sensor signal, selectable start and end points

Universal inputs

Universal inputs for:

- Passive or active analog input signals of various measured values (°C, %, ---)
- Digital input signals (potential-free contacts)

Control functions

- Universal controller (sequence controller) for 2 heating sequences (reverse acting) and 2 cooling sequences (direct acting), can be used as a controller providing P-, PI or PID mode, or as a differential controller
- Controller can be configured as a room/supply air temperature cascade controller with limitation of the supply air temperature
- Each sequence can be assigned modulating control (modulating output, step switch, mixed air damper/heat recovery equipment) and a pump. 2 sequences can act on the same modulating control (e.g. priority cooling/dehumidification)
- General limitation (minimum/maximum with PI mode per sequence controller, either as absolute limitation, e.g. for the supply air temperature or supply air humidity), or as relative temperature limitation (e.g. maximum limitation of the room/supply air temperature differential). Limitation acts on all sequences. Minimum limitation can be set to a lower setpoint while cooling is on (e.g. cooling with DX cooler battery)
- Sequence limitation with PI mode per universal controller, can be defined as minimum or maximum limitation. Limitation acts on a single sequence (e.g. heat recovery anti-icing protection or maximum limitation of the heating coil's return temperature)
- The mixed air temperature controller controls the mixed air temperature via the air dampers
- Locking of individual sequences
- Digital input (heating limit switch, from a heating controller) for changing the control strategy (room-supply air temperature cascade control), configurable

Switching and supervisory functions

- 2-stage frost protection (modulating/2-position) or frost protection thermostat (heating sequences delivering 100 % output, fault relay for switching off the fans) (with RLU220 only indication)
- Control of pumps, constantly ON at low outside temperatures, ON according to load sequence controller (not with RLU220); periodic activation of pump (pump kick)
- Control of an analog output (not with RLU202). Configurable external presetting (controller used as a pure signal converter). Minimum and maximum position, invertible.
Minimum limitation at low outside temperatures
- Control of mixed air dampers or heat recovery equipment with maximum economy changeover (not with RLU202), startup function at low outside temperatures
- Control of a multistage aggregate with a step switch, with a maximum of 6 steps and a modulating output.
The switching on/off points of each step can be adjusted. Adjustable delay times. Configurable external presetting (controller used as a pure step switch). Modulating output with minimum and maximum position, invertible (only with RLU236)
- Control of a multistage aggregate with a step switch, with a maximum of 2 steps and a modulating output.
Functions as described above (not with RLU220)
- Control of a linear multistage aggregate with a step switch, with a maximum of 6 steps and a modulating output.
Fixed assignment of switching on/off points to the load. Adjustable delay times and priority changeover. Configurable external presetting (controller used as a pure step switch). Modulating output for load assignment to the steps, with minimum and maximum position, invertible (only with RLU232 and RLU236)
- Control of a binary multistage aggregate with a step switch, with a maximum of 4 relays for 15 steps and a modulating output.
Fixed switching on/off points with binary switching logic. Adjustable delay times. Configurable external presetting (controller used as a pure step switch). Modulating output for load assignment to the steps, with minimum and maximum position, invertible (only with RLU232 and RLU236)
- Control of a modulating 3-position actuator. Configurable presetting (controller used as a pure analog/3-position converter) (only with RLU202 and RLU222)
- Delivery of a passive measuring signal as an active signal for use by other controllers

Type summary

<i>Type reference</i>	<i>Universal inputs</i>	<i>Digital inputs</i>	<i>Positioning outputs</i>	<i>Switching outputs</i>	<i>Number of control loops</i>
RLU202	4	1	0	2	1
RLU220	4	1	2	0	1
RLU222	4	1	2	2	2
RLU232	5	2	3	2	2
RLU236	5	2	3	6	2

Accessories

<i>Name</i>	<i>Type reference</i>
Mounting frame for flush panel mounting (consisting of 1 small frame, 1 large frame, 2 hexagonal spacers, 4 fixing screws, Mounting Instructions)	ARG62.201

Ordering

When ordering, please give name and type reference of the controller, e.g.:
Universal controller **RLU236**.
The products listed under "Accessories" must be ordered as separate items.

Equipment combinations

For equipment combinations, refer to the Basic Documentation P3101 or to the document covering the selected application.

Product documentation

<i>Document type</i>	<i>Document number</i>
Basic Documentation: Universal Controllers RLU2...	CE1P3101en
Instructions Set (mounting, commissioning, operation)	74 319 0424 0
Declaration of Conformity (CE): RLU2...	CE1T3101xx
Environmental Declaration: RLU202, RLU220, RLU222	CE1E3101en01
Environmental Declaration: RLU232 and RLU236	CE1E3101en02

Technical design

Each controller offers up to 45 ready programmed applications. When commissioning a plant, the relevant basic type must be entered. All associated functions, terminal assignments, settings and displays will then automatically be activated and parameters that are not required will be deactivated.

In addition, each type of universal controller has 2 empty applications loaded:

- 1 for basic type A (ventilation controller)
- 1 for basic type U (universal controller)

With the help of the built-in operation or the OCI700.1 service tool, the controller affords:

- Activation of a programmed application (refer to "Programmed standard applications")
- Modification of a programmed application
- Free configuration of applications
- Optimization of the controller settings

For operating actions of the functions, refer to the Basic Documentation.

Mechanical design

The universal controller consists of terminal base and controller insert with built-in operation.

The terminal base can be fitted to a DIN mounting rail or is screwed directly on a flat surface. It consists of a plastic housing with 2 terminal levels.

The controller insert engages in the terminal base. It consists of a plastic housing which accommodates the printed circuit boards.

Controller operation is fully integrated.

Operating, display and connecting elements

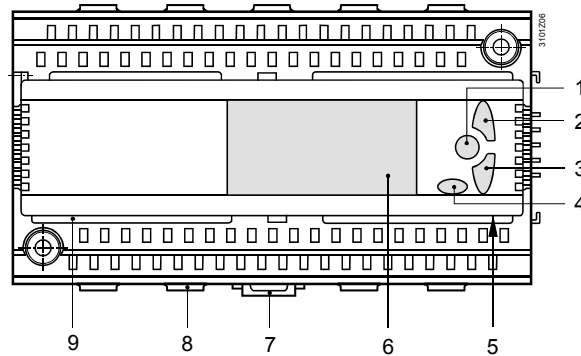

Legend

- | | |
|---|---|
| 1 | OK button for confirming the selected menu line or the value entered |
| 2 | Navigation button, upward (+) for selecting the menu line or changing the value |
| 3 | Navigation button, downward (-) for selecting the menu line or changing the value |
| 4 | ESC button for returning to the previous menu or for rejecting the value entered |
| 5 | Connection facility for the service tool (RJ45 connector) |
| 6 | Display |
| 7 | Catch for fitting the controller to a top hat rail |
| 8 | Fixing facility for a cable tie (cable strain relief) |
| 9 | Rest for the terminal cover |

Engineering notes



- The controller operates on AC 24 V. Operating voltage must conform to the requirements of SELV/PELV (safety extra low-voltage)
- The transformers used must be safety isolating transformers featuring double insulation to EN 60 742 or EN 61 558-2-6; they must be suited for 100 % duty
- Fuses, switches, wiring and earthing must be in compliance with local regulations
- Sensor wires should not be run parallel to mains carrying wires that power fans, actuators, pumps, etc.
- It is recommended to use the standard applications provided. Specific plant situations may require certain adaptations however

Mounting and installation notes

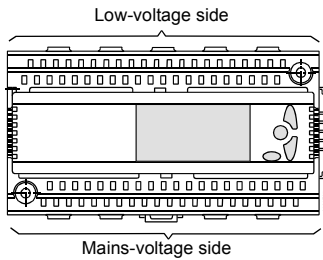

- Controllers and extension modules are designed for:
 - Mounting in a standard cabinet to DIN 43 880
 - Wall mounting on an existing top hat rail (to EN 60715-TH35-7.5)
 - Wall mounting with 2 fixing screws
 - Flush panel mounting with ARG62.201 mounting frame
- Not permitted are wet or damp spaces. The permissible environmental conditions must be observed
- Disconnected the system from the power supply prior to mounting the controller
- **The controller insert must not be removed from the terminal base!**
- All connection terminals for protective extra low-voltage are located in the upper half of the unit, those for mains voltage at the bottom
- Each terminal (spring cage terminal) can accommodate only 1 solid wire or 1 stranded wire. For making the connections, the cables must be stripped for 7 to 8 mm. To introduce the cables into the spring cage terminals and to remove them, a screw driver size 1 is required. Cable strain relief can be provided with the help of the fixing facility for cable ties
- The controller is supplied complete with Installation and Operating Instructions

Commissioning notes

- The configuration and parameters of the standard applications offered by the controller can be changed any time by service staff who have been trained by HVAC Products and who have the required access rights, either locally or online/offline with the service tool
- During the commissioning process, the application is deactivated and the outputs are in a defined off state
- On completion of the configuration, the controller automatically makes a new start
- When leaving the commissioning pages, the peripheral devices connected to the universal inputs (including the extension modules) are automatically tested and identified. If a peripheral device is missing, a fault status message will be delivered
- If adaptations to specific plants are required, they must be recorded and the documentation kept inside the control panel
- For the procedure to be followed when starting up the plant for the first time, refer to the Installation Instructions

Disposal notes



The device is classified as waste electronic equipment in terms of the European Directive 2002/96/EC (WEEE) and should not be disposed of as unsorted municipal waste. The relevant national legal rules are to be adhered to. Regarding disposal, use the systems setup for collecting electronic waste. Observe all local and applicable laws.

Technical data

Power supply (G, G0)	Rated voltage	AC 24 V \pm 20 %
	Safety extra low-voltage (SELV) / protective extra low-voltage (PELV) to Requirements for external safety isolating transformer to	HD 384 EN 60 742 / EN 61 558-2-6, min. 10 VA, max. 320 VA
	Frequency	50/60 Hz
	Power consumption	
	RLU202, RLU220, RLU222	5 VA
RLU232, RLU236	6 VA	
Supply line fusing		max. 10 A
Universal inputs Measured value inputs (X...)	Number	refer to "Type summary"
	Sensors	
	Passive	LG-Ni 1000, T1, Pt 1000 2x LG-Ni 1000 (averaging)
	Active	DC 0...10 V
	Signal sources	
Passive	0...1000 Ω / 1000...1175 Ω	
Active	DC 0...10 V	
Digital inputs (X..., D...)	Contact sensing	
	Voltage	DC 15 V
	Current	5 mA
	Requirements for status and impulse contacts	
	Signal coupling	potential-free
Type of contact	maintained or impulse contacts	
Insulating strength against mains potential	AC 3750 V to EN 60 730	
Perm. resistance		
Contacts closed		max. 200 Ω
Contacts open		min. 50 k Ω
Outputs Positioning outputs Y...	Number of positioning and switching outputs	refer to "Type summary"
	Output voltage	DC 0...10 V
	Output current	\pm 1 mA
	Max. load	continuous short-circuit
 Switching outputs AC 230 V (Q1x...Q6x)	External supply line fusing	
	Non-renewable fuse (slow)	max. 10 A
	Automatic line cutout	max. 13 A
	Release characteristic	B, C, D to EN 60 898
	Cable length	max. 300 m
	Relay contacts	
	Switching voltage	max. AC 265 V min. AC 19 V
	AC current	max. 4 A ohm., 3 A ind. (cos φ = 0.6)
	At 250 V	min. 5 mA
	At 19 V	min. 20 mA
	Switch-on current	max. 10 A (1 s)
	Contact life at AC 250 V	guide values:
At 0.1 A res.	2 x 10 ⁷ cycles	
At 0.5 A res.	4 x 10 ⁶ cycles (NO) 2 x 10 ⁶ cycles (changeover)	
At 4 A res.	3 x 10 ⁵ cycles (NO) 1 x 10 ⁵ cycles (changeover)	
Red. factor at ind. (cos φ = 0.6)	0.85	

	Insulating strength	
	Between relay contacts and system electronics (reinforced insulation)	AC 3750 V, to EN 60 730-1
	Between neighboring relay contacts (operational insulation)	
	Q1↔Q2; Q3↔Q4; Q5↔Q6	AC 1250 V, to EN 60 730-1
	Between relay groups (reinforced insulation)	
	(Q1, Q2) ↔ (Q3, Q4) ↔ (Q5, Q6)	AC 3750 V, to EN 60 730-1
Power supply external devices (G1)	Voltage	AC 24 V
	Current	max. 4 A
Interfaces	Service tool connection facility	RJ45 connector
Perm. cable lengths	For passive measuring and positioning signals	(measuring errors can be corrected)
	Type of signal	
	LG-Ni 1000, T1	max. 300 m
	Pt 1000	max. 300 m
	0...1000 Ω	max. 300 m
	1000...1235 Ω	max. 300 m
	Contact sensing	max. 300 m
	For DC 0...10 V measuring and control signals	refer to Data Sheet of the signal delivering device
Electrical connections	Connection terminals	spring cage terminals
	For wires	0.6 mm dia....2.5 mm ²
	For stranded wires without ferrules	0.25...2.5 mm ²
	For stranded wires with ferrules	0.25...1.5 mm ²
Degrees of protection	Degree of protection of housing to IEC 60 529	IP 20 (when mounted)
	Safety class to EN 60 730	device suited for use with equipment of safety class II
Environmental conditions	Operation to	IEC 60 721-3-3
	Climatic conditions	class 3K5
	Temperature (housing and electronics)	0...50 °C
	Humidity	5...95 % r.h. (non-condensing)
	Mechanical conditions	class 3M2
	Transport to	IEC 60 721-3-2
	Climatic conditions	class 2K3
	Temperature	-25...+70 °C
	Humidity	<95 % r.h.
	Mechanical conditions	class 2M2
Classifications to EN 60 730	Mode of operation, automatic controls	type 1B
	Degree of contamination, controls' environment	2
	Software class	A
	Rated surge voltage	4000 V
	Temperature for ball-pressure test of housing	125 °C
Materials and colors	Terminal base	Polycarbonate, RAL 7035 (light-grey)
	Controller insert	Polycarbonate, RAL 7035 (light-grey)
	Packaging	corrugated cardboard

Standards	CE-conformity	
	EMC directive	2004/108/EC
	Low-voltage directive	2006/95/EC
	Electromagnetic compatibility for industrial and domestic sector	
	Immunity	EN 60730-1
	Emissions	EN 60730-1
	UL approvals	UL916 (Energy Management Equipment)
Environmental compatibility	The product environmental declaration	ISO 14001 (Environment)
	CE1E3101en01/02 contains data on environmentally compatible product design and assessments (RoHS compliance, materials composition, packaging, environmental benefit, disposal)	ISO 9001 (Quality) RL 2002/95/EC (RoHS)
Weight, excl. packaging	RLU202	0,334 kg
	RLU220	0,292 kg
	RLU222	0,334 kg
	RLU232	0,437 kg
	RLU236	0,481 kg

Connection diagrams

Internal diagrams

RLU202

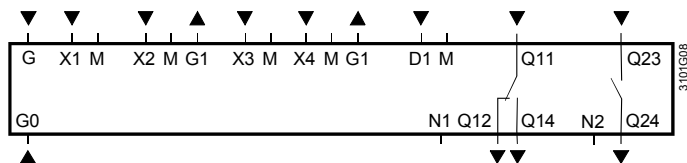

RLU220

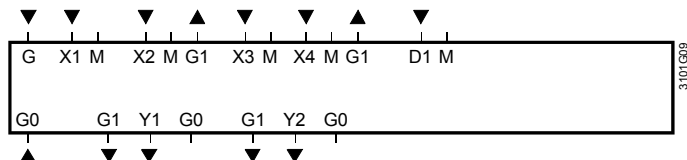

RLU222

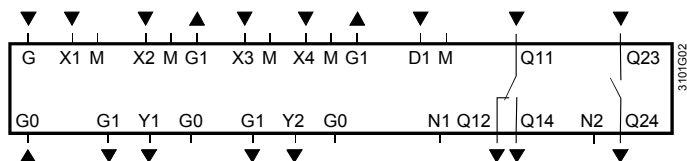

RLU232

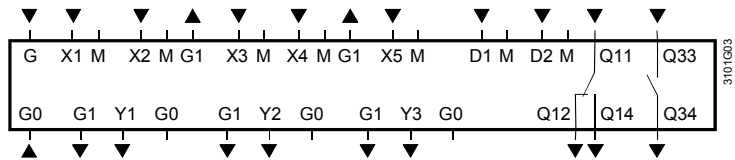

RLU236

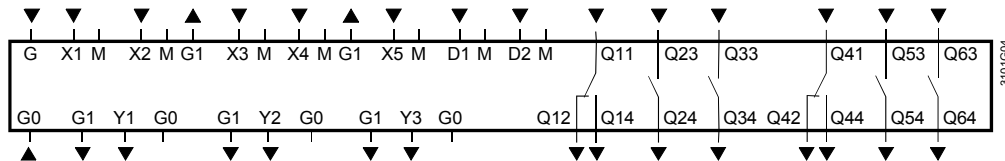

Legend

G, G0	Rated voltage AC 24 V
G1	Output voltage AC 24 V for powering external active sensors, signal sources, monitors or setting units
M	Measuring neutral for signal input
G0	System neutral for signal output
X...	Universal signal inputs for LG-Ni 1000, 2x LG-Ni 1000 (averaging), T1, Pt 1000, DC 0...10 V, 0...1000 Ω (= REM), 1000...1175 Ω (= REL)
X..., D...	Contact sensing (potential-free)
Y...	Control or status outputs, analog DC 0...10 V
Q...	Potential-free relay outputs for AC 24...230 V
N1, N2	Neutral conductor connection for radio interference suppression elements

Notes

- Each terminal (spring cage terminal) can only accommodate 1 solid wire or 1 stranded wire. Double terminals are internally interconnected
- If a 3-position AC 230 V actuator is used, the radio suppression element must be activated: Connect terminal N1 to the neutral conductor and fit a wire link between N1 and N2 (see connection diagram 5)

Connection diagrams

Connections on the measuring side

Examples:

Connection diagram 1: Measuring section with passive main and auxiliary sensors and passive signal source

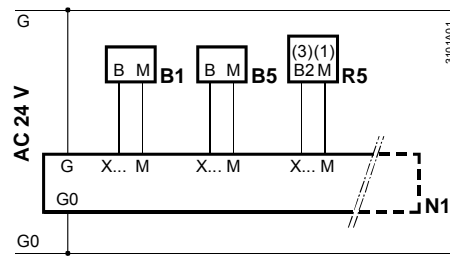

Connection diagram 2: Measuring section with active sensor and active signal source

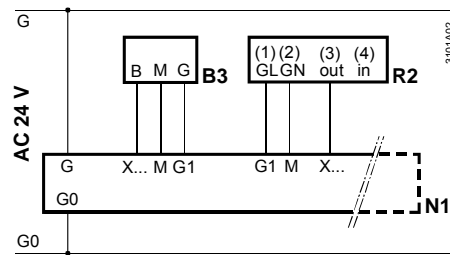

Connection diagrams 3 and 4: Measuring section with CO₂/VOC- and CO₂-evaluation

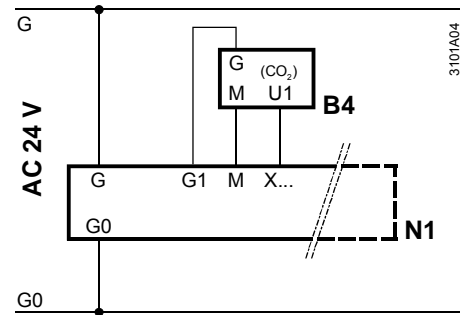
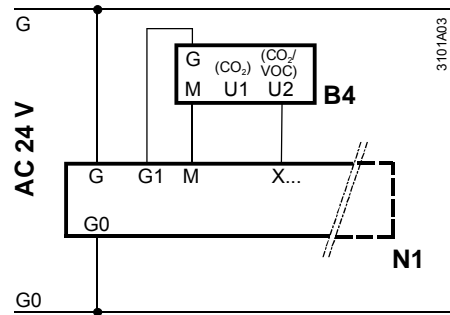

Connections on the control and monitoring side

Connection diagram 5:

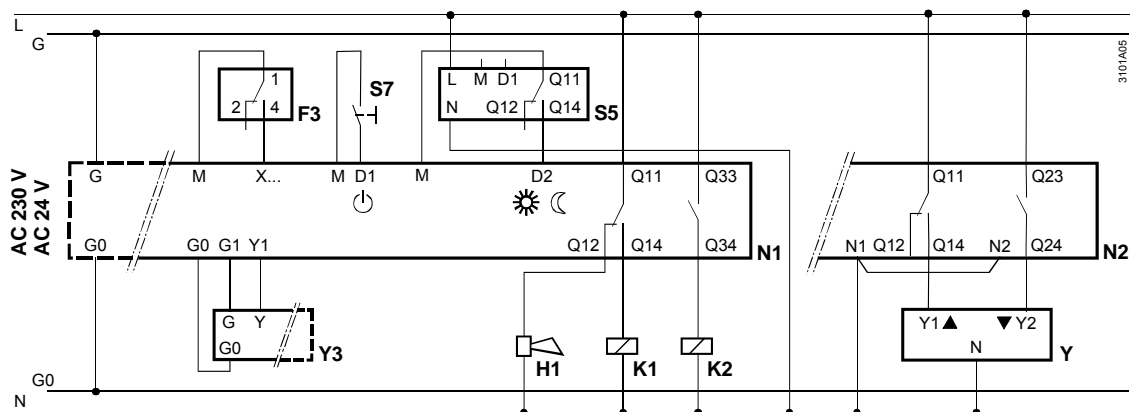

Legend to the connection diagrams 1 through 5

- | | | | |
|----|---|----|--|
| N1 | Universal controller RLU2... | K1 | Fan release relay |
| N2 | Universal controller RLU222 | K2 | Pump release relay |
| B1 | Supply air temperature sensor QAM2120.040 | R2 | Setpoint adjuster BSG61 |
| B3 | Frost sensor QAF63.2/QAF63... | R5 | Setpoint readjuster BSG21.5 |
| B4 | CO ₂ /VOC sensor QPA2002/2002D | S4 | On/off switch "Locking signal" |
| B4 | CO ₂ sensor QPA2000 | S5 | Digital time switch SEH62.1 |
| B5 | Room temperature sensor QAA24 | S7 | Manual switch "On/Standby" |
| F3 | Frost unit QAF81... | Y | Actuating device with 3-position control |
| H1 | Horn for fault status message from fan | Y3 | Actuating device for heating |

Preprogrammed standard applications

Note The plant diagrams / connection diagrams assigned to the basic types are only examples.

Controller- / basic type	Application no. / description	Plant diagram / connection diagram
RLU202 A01	ADA006 LU0 HQ Extract air (room) temperature control with electric air heater battery. <i>Options:</i> <ul style="list-style-type: none"> • Minimum and maximum limitation of the supply air temperature • Outside temperature-dependent functions • Remote setpoint readjuster • 2-stage electric air heater battery • Comfort / Protection Mode changeover (time switch) 	
RLU202 A02	ADA012 LU0 HQ Supply air temperature control with electric air heater battery. <i>Options:</i> <ul style="list-style-type: none"> • Room temperature cascade control • Outside temperature-dependent functions • Remote setpoint readjuster • 2-stage electric air heater battery • Comfort / Protection Mode changeover (time switch) 	
RLU202 A03	ADA014 LU0 HQ Supply air temperature control with hot water heating coil. <i>Options:</i> <ul style="list-style-type: none"> • Room temperature cascade control • Outside temperature-dependent functions • Remote setpoint readjuster • Comfort / Protection Mode changeover (time switch) 	
RLU202 A04	ADB003 LU0 HQ Extract air (room) temperature control with DX cooler battery. <i>Options:</i> <ul style="list-style-type: none"> • Minimum and maximum limitation of the supply air temperature • Outside temperature-dependent functions • Remote setpoint readjuster • 2-stage DX cooler battery • Comfort / Protection Mode changeover (time switch) 	
RLU202 A05	ADB007 LU0 HQ Supply air temperature control with DX cooler battery. <i>Options:</i> <ul style="list-style-type: none"> • Room temperature cascade control • Outside temperature-dependent functions • Remote setpoint readjuster • 2-stage DX cooler battery • Comfort / Protection Mode changeover (time switch) 	
RLU202 A06	AEC001 LU0 HQ Extract air (room) temperature control with hot water heating coil and DX cooler battery. <i>Options:</i> <ul style="list-style-type: none"> • Minimum and maximum limitation of the supply air temperature • Outside temperature-dependent functions • Remote setpoint readjuster • Comfort / Protection Mode changeover (time switch) 	

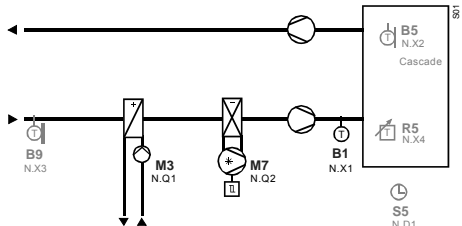
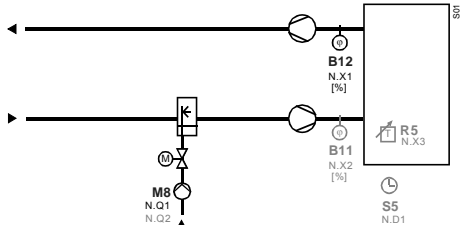
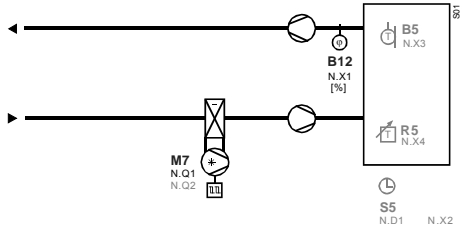
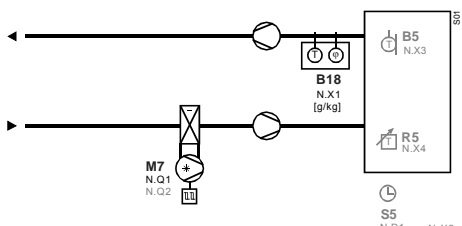
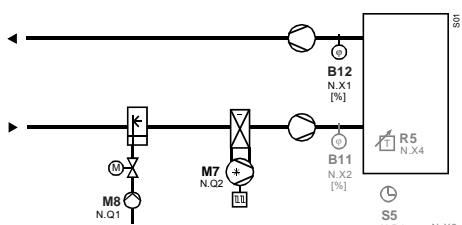
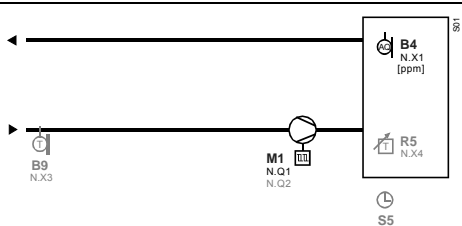
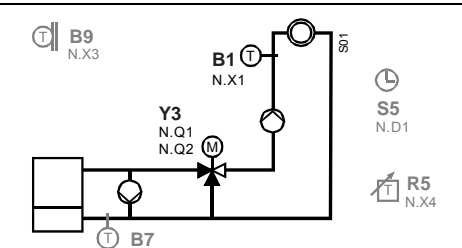
Controller- / basic type	Application no. / description	Plant diagram / connection diagram
RLU202 A07	AEC002 LU0 HQ Supply air temperature control with hot water heating coil and DX cooler battery. <i>Options:</i> <ul style="list-style-type: none"> • Room temperature cascade control • Outside temperature-dependent functions • Remote setpoint readjuster • Comfort / Protection Mode changeover (time switch) 	
RLU202 U01	ADKA02 LU0 HQ Extract air (room) humidity control (r.h.) with spray humidifier. <i>Options:</i> <ul style="list-style-type: none"> • Maximum limitation of the air humidity • Remote setpoint adjuster • 2-stage spray humidifier • Comfort / Protection Mode changeover (time switch) 	
RLU202 U02	ADI003 LU0 HQ Extract air (room) humidity control (r.h.) with DX cooler battery. <i>Options:</i> <ul style="list-style-type: none"> • Additional maximum selection from internal and external signal • Room temperature-dependent shifting of humidity setpoint • Remote setpoint adjuster • 2-stage DX cooler battery • Comfort / Protection Mode changeover (time switch) 	
RLU202 U03	ADI005 LU0 HQ Extract air (room) humidity control (a.h.) with DX cooler battery. <i>Options:</i> <ul style="list-style-type: none"> • Additional maximum selection from internal and external signal • Room temperature-dependent shifting of humidity setpoint • Remote setpoint adjuster • 2-stage DX cooler battery • Comfort / Protection Mode changeover (time switch) 	
RLU202 U04	ADZA01 LU0 HQ Extract air (room) humidity control (r.h.) with spray humidifier and DX cooler battery. <i>Options:</i> <ul style="list-style-type: none"> • Maximum limitation of the supply air humidity • Additional maximum selection from internal and external signal • Remote setpoint adjuster • Comfort / Protection Mode changeover (time switch) 	
RLU202 U05	AZZ001 LU0 HQ Indoor air quality control with fan control. <i>Options:</i> <ul style="list-style-type: none"> • Additional maximum selection from internal and external signal • Outside temperature-dependent functions • Remote setpoint adjuster • 2-speed fan • Comfort / Protection Mode changeover (time switch) 	
RLU202 U06	HZC001 LU0 HQ Temperature control of mixing heating circuit. <i>Options:</i> <ul style="list-style-type: none"> • Minimum limitation of the return temperature • Outside temperature-dependent functions • Remote setpoint adjuster • Comfort / Protection Mode changeover (time switch) 	

Controller- / basic type	Application no. / description	Plant diagram / connection diagram
RLU202 U07	HZC002 LU0 HQ Boiler temperature control (substitute for RCA12.2) <i>Application:</i> Minimum limitation of the boiler return temperature <i>Options:</i> <ul style="list-style-type: none"> • Remote setpoint adjuster (absolute) • Comfort / Protection Mode changeover (time switch) 	
RLU202 U08	ADC019 LU0 HQ Universal control (substitute for RKN2 / RKN22) <i>Application:</i> Temperature control (on/off pump control) <i>Options:</i> <ul style="list-style-type: none"> • Remote setpoint adjuster (absolute) • Comfort / Protection changeover 	
RLU202 U09	SA0001 LU0 HQ Differential temperature control (substitute for RSA24) <i>Application:</i> Solar heat storage plant <i>Options:</i> <ul style="list-style-type: none"> • Maximum limitation of the boiler temperature • Minimum limitation of the charging temperature • Comfort / Protection Mode changeover (time switch) 	
RLU202 U10	ZZZ001 LU0 HQ 3-position actuator	
RLU202 U11	ZZZ002 LU0 HQ Variable 2-step switch	
RLU220 A01	ADA001 LU2 HQ Extract air (room) temperature control with hot water heating coil. <i>Options:</i> <ul style="list-style-type: none"> • Minimum and maximum limitation of the supply air temperature • Remote setpoint readjuster • Outside temperature-dependent functions • Comfort / Protection Mode changeover (time switch) 	
RLU220 A02	ADA008 LU2 HQ Supply air temperature control with hot water heating coil. <i>Options:</i> <ul style="list-style-type: none"> • Room temperature cascade control • Remote setpoint readjuster • Outside temperature-dependent functions • Comfort / Protection Mode changeover (time switch) 	

Controller- / basic type	Application no. / description	Plant diagram / connection diagram
RLU220 A03	ADA003 LU2 HQ Extract air (room) temperature control with hot water heating coil and frost protection. <i>Options:</i> <ul style="list-style-type: none"> • Minimum and maximum limitation of the supply air temperature • Outside temperature-dependent functions • Comfort / Protection Mode changeover (time switch) 	
RLU220 A04	ADA010 LU2 HQ Supply air temperature control with hot water heating coil and frost protection. <i>Options:</i> <ul style="list-style-type: none"> • Room temperature cascade control • Outside temperature-dependent functions • Comfort / Protection Mode changeover (time switch) 	
RLU220 A05	ADA017 LU2 HQ Extract air (room) temperature control with hot water heating coil, frost protection. <i>Options:</i> <ul style="list-style-type: none"> • Minimum and maximum limitation of the supply air temperature • Remote setpoint readjuster • Comfort / Protection Mode changeover (time switch) 	
RLU220 A06	ADB001 LU2 HQ Extract air (room) temperature control with chilled water cooling coil. <i>Options:</i> <ul style="list-style-type: none"> • Minimum and maximum limitation of the supply air temperature • Remote setpoint readjuster • Outside temperature-dependent functions • Comfort / Protection Mode changeover (time switch) 	
RLU220 A07	ADB005 LU2 HQ Supply air temperature control with chilled water cooling coil. <i>Options:</i> <ul style="list-style-type: none"> • Room temperature cascade control • Remote setpoint readjuster • Outside temperature-dependent functions • Comfort / Protection Mode changeover (time switch) 	
RLU220 A08	ACAD01 LU2 HQ Extract air (room) temperature control with mixed air dampers and outside temperature-dependent functions. <i>Options:</i> <ul style="list-style-type: none"> • Additional maximum selection from internal and external signal • Comfort / Protection Mode changeover (time switch) 	
RLU220 A09	ABC001 LU2 HQ Supply air temperature control with heating / cooling coil and frost protection. <i>Options:</i> <ul style="list-style-type: none"> • Outside temperature-dependent functions • Comfort / Protection Mode changeover (time switch) 	

Controller- / basic type	Application no. / description	Plant diagram / connection diagram
RLU220 A10	ADC021 LU2 HQ Extract air (room) temperature control with hot water heating coil and chilled water cooling coil. <i>Options:</i> <ul style="list-style-type: none"> • Room temperature cascade control • Outside temperature-dependent functions • Remote setpoint readjuster • Comfort / Protection Mode changeover (time switch) 	
RLU220 A11	ADC023 LU2 HQ Supply air temperature control with hot water heating coil and chilled water cooling coil. <i>Options:</i> <ul style="list-style-type: none"> • Room temperature cascade control • Outside temperature-dependent functions • Remote setpoint readjuster • Comfort / Protection Mode changeover (time switch) 	
RLU220 A12	ADC022 LU2 HQ Extract air (room) temperature control with hot water heating coil, frost protection, chilled water cooling coil. <i>Options:</i> <ul style="list-style-type: none"> • Minimum and maximum limitation of the supply air temperature • Outside temperature-dependent functions • Comfort / Protection Mode changeover (time switch) 	
RLU220 A13	ADC024 LU2 HQ Supply air temperature control with hot water heating coil, frost protection, chilled water cooling coil. <i>Options:</i> <ul style="list-style-type: none"> • Room temperature cascade control • Outside temperature-dependent functions • Comfort / Protection Mode changeover (time switch) 	
RLU220 A14	AEAF03 LU2 HQ Extract air (room) temperature control with closed-circuit heat recovery system and hot water heating coil. <i>Options:</i> <ul style="list-style-type: none"> • Minimum and maximum limitation of the supply air temperature • Outside temperature-dependent functions • Remote setpoint readjuster • Comfort / Protection Mode changeover (time switch) 	
RLU220 A15	AEAF04 LU2 HQ Supply air temperature control with closed-circuit heat recovery system and hot water heating coil. <i>Options:</i> <ul style="list-style-type: none"> • Room temperature cascade control • Outside temperature-dependent functions • Remote setpoint readjuster • Comfort / Protection Mode changeover (time switch) 	
RLU220 A16	AEAD03 LU2 HQ Extract air (room) temperature control with mixed air dampers, hot water heating coil, frost protection. <i>Options:</i> <ul style="list-style-type: none"> • Minimum and maximum limitation of the supply air temperature • Outside temperature-dependent functions • Comfort / Protection Mode changeover (time switch) 	

Controller- / basic type	Application no. / description	Plant diagram / connection diagram
RLU220 A17	AEAD04 LU2 HQ Supply air temperature control with mixed air dampers, hot water heating coil, frost protection. <i>Options:</i> <ul style="list-style-type: none"> • Room temperature cascade control • Outside temperature-dependent functions • Comfort / Protection Mode changeover (time switch) 	
RLU220 A18	ADB012 LU2 HQ Extract air (room) temperature control with chilled water cooling coil and 2 cooling towers. <i>Options:</i> <ul style="list-style-type: none"> • Minimum and maximum limitation of the supply air temperature • Outside temperature-dependent functions • Remote setpoint readjuster • Comfort / Protection Mode changeover (time switch) 	
RLU220 U01	ADKA01 LU2 HQ Extract air (room) humidity control (r.h.) with spray humidifier. <i>Options:</i> <ul style="list-style-type: none"> • Maximum limitation of the supply air humidity • Remote setpoint adjuster • Comfort / Protection Mode changeover (time switch) 	
RLU220 U02	ADI001 LU2 HQ Extract air (room) humidity control (r.h.) with chilled water cooling coil. <i>Options:</i> <ul style="list-style-type: none"> • Additional maximum selection from internal and external signal • Remote setpoint adjuster • Comfort / Protection Mode changeover (time switch) 	
RLU220 U03	ADI002 LU2 HQ Extract air (room) humidity control (a.h.) with chilled water cooling coil. <i>Options:</i> <ul style="list-style-type: none"> • Additional maximum selection from internal and external signal • Remote setpoint adjuster • Comfort / Protection Mode changeover (time switch) 	
RLU220 U04	PB0001 LU2 HQ Differential pressure control of water with speed-controlled pump. <i>Options:</i> <ul style="list-style-type: none"> • Minimum and maximum limitation of the differential pressure • Remote setpoint adjuster • Comfort / Protection Mode changeover (time switch) 	
RLU220 U05	PB0004 LU2 HQ Differential pressure control of water with speed-controlled pumps. <i>Options:</i> <ul style="list-style-type: none"> • Minimum and maximum pressure limit controller • Outside temperature-dependent functions • Remote setpoint adjuster • Comfort / Protection Mode changeover (time switch) 	

Controller- / basic type	Application no. / description	Plant diagram / connection diagram
RLU220 U06	AZL001 LU2 HQ Differential pressure control of air with speed-controlled fan. <i>Options:</i> <ul style="list-style-type: none"> • Minimum and maximum limitation of the differential pressure • Remote setpoint adjuster • Comfort / Protection Mode changeover (time switch) 	
RLU220 U07	AZL004 LU2 HQ Differential pressure control of air with speed-controlled fans. <i>Options:</i> <ul style="list-style-type: none"> • Minimum and maximum pressure limit controller • Outside temperature-dependent functions • Remote setpoint adjuster • Comfort / Protection Mode changeover (time switch) 	
RLU220 U08	AAZD01 LU2 HQ Indoor air quality control with mixed air dampers. <i>Options:</i> <ul style="list-style-type: none"> • Additional maximum selection from internal and external signal • Remote setpoint adjuster • Comfort / Protection Mode changeover (time switch) 	
RLU220 U09	CZC002 LU2 HQ Temperature control of chilled ceilings. <i>Options:</i> <ul style="list-style-type: none"> • Setpoint compensation depending on humidity • Deviation alarm • Comfort / Protection Mode changeover (time switch) 	
RLU220 U10	ADC025 LU2 HQ Universal control (substitute for RKN8 / RKN88) <i>Application:</i> Temperature control (modulating valve control) <i>Options:</i> <ul style="list-style-type: none"> • Remote setpoint adjuster (absolute) • Comfort / Protection Mode changeover (time switch) 	
RLU222 A01	ADA006 LU2 HQ Extract air (room) temperature control with electric air heater battery. <i>Options:</i> <ul style="list-style-type: none"> • Minimum and maximum limitation of the supply air temperature • Outside temperature-dependent functions • Remote setpoint readjuster • 2-stage electric air heater battery • Comfort / Protection Mode changeover (time switch) 	
RLU222 A02	ADA012 LU2 HQ Supply air temperature control with electric air heater battery. <i>Options:</i> <ul style="list-style-type: none"> • Room temperature cascade control • Outside temperature-dependent functions • Remote setpoint readjuster • 2-stage electric air heater battery • Comfort / Protection Mode changeover (time switch) 	

Controller- / basic type	Application no. / description	Plant diagram / connection diagram
RLU222 A03	ADA014 LU2 HQ Supply air temperature control with hot water heating coil. <i>Options:</i> <ul style="list-style-type: none"> • Room temperature cascade control • Outside temperature-dependent functions • Remote setpoint readjuster • Comfort / Protection Mode changeover (time switch) 	
RLU222 A04	ADA004 LU2 HQ Extract air (room) temperature control with hot water heating coil, frost protection and fan release. <i>Options:</i> <ul style="list-style-type: none"> • Minimum and maximum limitation of the supply air temperature • Outside temperature-dependent functions • Comfort / Protection Mode changeover (time switch) 	
RLU222 A05	ADA005 LU2 HQ Extract air (room) temperature control with hot water heating coil, frost protection and fan release. <i>Options:</i> <ul style="list-style-type: none"> • Minimum and maximum limitation of the supply air temperature • Remote setpoint readjuster • Comfort / Protection Mode changeover (time switch) 	
RLU222 A06	ADA0011 LU2 HQ Supply air temperature control with hot water heating coil, frost protection and fan release. <i>Options:</i> <ul style="list-style-type: none"> • Room temperature cascade control • Outside temperature-dependent functions • Comfort / Protection Mode changeover (time switch) 	
RLU222 A07	ADB003 LU2 HQ Extract air (room) temperature control with DX cooler battery. <i>Options:</i> <ul style="list-style-type: none"> • Minimum and maximum limitation of the supply air temperature • Outside temperature-dependent functions • Remote setpoint readjuster • 2-stage DX cooler battery • Comfort / Protection Mode changeover (time switch) 	
RLU222 A08	ADB007 LU2 HQ Supply air temperature control with DX cooler battery. <i>Options:</i> <ul style="list-style-type: none"> • Room temperature cascade control • Outside temperature-dependent functions • Remote setpoint readjuster • 2-stage DX cooler battery • Comfort / Protection Mode changeover (time switch) 	
RLU222 A09	ADC002 LU2 HQ Extract air (room) temperature control with hot water heating coil and chilled water cooling coil. <i>Options:</i> <ul style="list-style-type: none"> • Room temperature cascade control • Outside temperature-dependent functions • Remote setpoint readjuster • Comfort / Protection Mode changeover (time switch) 	

Controller- / basic type	Application no. / description	Plant diagram / connection diagram
RLU222 A10	ADC010 LU2 HQ Supply air temperature control with hot water heating coil and chilled water cooling coil. <i>Options:</i> <ul style="list-style-type: none"> • Room temperature cascade control • Outside temperature-dependent functions • Remote setpoint readjuster • Comfort / Protection Mode changeover (time switch) 	
RLU222 A11	ADC004 LU2 HQ Extract air (room) temperature control with electric air heater battery and chilled water cooling coil. <i>Options:</i> <ul style="list-style-type: none"> • Minimum and maximum limitation of the supply air temperature • Outside temperature-dependent functions • Remote setpoint readjuster • 2-stage electric air heater battery • Comfort / Protection Mode changeover (time switch) 	
RLU222 A12	ADC012 LU2 HQ Supply air temperature control with electric air heater battery and chilled water cooling coil. <i>Options:</i> <ul style="list-style-type: none"> • Room temperature cascade control • Outside temperature-dependent functions • Remote setpoint readjuster • 2-stage electric air heater battery • Comfort / Protection Mode changeover (time switch) 	
RLU222 A13	ADC003 LU2 HQ Extract air (room) temperature control with hot water heating coil and DX cooler battery. <i>Options:</i> <ul style="list-style-type: none"> • Minimum and maximum limitation of the supply air temperature • Outside temperature-dependent functions • Remote setpoint readjuster • 2-stage DX cooler battery • Comfort / Protection Mode changeover (time switch) 	
RLU222 A14	ADC011 LU2 HQ Supply air temperature control with hot water heating coil and DX cooler battery. <i>Options:</i> <ul style="list-style-type: none"> • Room temperature cascade control • Outside temperature-dependent functions • Remote setpoint readjuster • 2-stage DX cooler battery • Comfort / Protection Mode changeover (time switch) 	
RLU222 A15	ADC006 LU2 HQ Extract air (room) temperature control with hot water heating coil, frost protection, chilled water cooling coil and fan release. <i>Options:</i> <ul style="list-style-type: none"> • Minimum and maximum limitation of the supply air temperature • Outside temperature-dependent functions • Comfort / Protection Mode changeover (time switch) 	
RLU222 A16	ADC014 LU2 HQ Supply air temperature control with hot water heating coil, frost protection, chilled water cooling coil and fan release. <i>Options:</i> <ul style="list-style-type: none"> • Room temperature cascade control • Outside temperature-dependent functions • Comfort / Protection Mode changeover (time switch) 	

Controller- / basic type	Application no. / description	Plant diagram / connection diagram
RLU222 A17	ADC007 LU2 HQ Extract air (room) temperature control with hot water heating coil, frost protection, DX cooler battery and fan release. <i>Options:</i> <ul style="list-style-type: none"> • Minimum and maximum limitation of the supply air temperature • Outside temperature-dependent functions • Comfort / Protection Mode changeover (time switch) 	
RLU222 A18	ADC016 LU2 HQ Supply air temperature control with hot water heating coil, frost protection, DX cooler battery and fan release. <i>Options:</i> <ul style="list-style-type: none"> • Room temperature cascade control • Outside temperature-dependent functions • Comfort / Protection Mode changeover (time switch) 	
RLU222 A19	AEAG01 LU2 HQ Extract air (room) temperature control with closed-circuit heat recovery system and hot water heating coil. <i>Options:</i> <ul style="list-style-type: none"> • Minimum and maximum limitation of the supply air temperature • Outside temperature-dependent functions • Remote setpoint readjuster • Comfort / Protection Mode changeover (time switch) 	
RLU222 A20	AEAG02 LU2 HQ Supply air temperature control with closed-circuit heat recovery system and hot water heating coil. <i>Options:</i> <ul style="list-style-type: none"> • Room temperature cascade control • Outside temperature-dependent functions • Remote setpoint readjuster • Comfort / Protection Mode changeover (time switch) 	
RLU222 A21	AEAD01 LU2 HQ Extract air (room) temperature control with mixed air dampers, hot water heating coil, frost protection and fan release. <i>Options:</i> <ul style="list-style-type: none"> • Minimum and maximum limitation of the supply air temperature • Outside temperature-dependent functions • Comfort / Protection Mode changeover (time switch) 	
RLU222 A22	AEAD02 LU2 HQ Supply air temperature control with mixed air dampers, hot water heating coil, frost protection and fan release. <i>Options:</i> <ul style="list-style-type: none"> • Room temperature cascade control • Outside temperature-dependent functions • Comfort / Protection Mode changeover (time switch) 	
RLU222 A23	ADB009 LU2 HQ Extract air (room) temperature control with chilled water cooling coil and 2 cooling towers. <i>Options:</i> <ul style="list-style-type: none"> • Minimum and maximum limitation of the supply air temperature • Outside temperature-dependent functions • Remote setpoint readjuster • Comfort / Protection Mode changeover (time switch) 	

Controller- / basic type	Application no. / description	Plant diagram / connection diagram
RLU222 A24	AECD01 LU2 HQ Extract air (room) temperature control with mixed air dampers, hot water heating coil and DX cooler battery. <i>Options:</i> <ul style="list-style-type: none"> • Minimum and maximum limitation of the supply air temperature • Outside temperature-dependent functions • Remote setpoint readjuster • Comfort / Protection Mode changeover (time switch) 	
RLU222 A25	AECD04 LU2 HQ Supply air temperature control with mixed air dampers, hot water heating coil and DX cooler battery. <i>Options:</i> <ul style="list-style-type: none"> • Room temperature cascade control • Outside temperature-dependent functions • Remote setpoint readjuster • Comfort / Protection Mode changeover (time switch) 	
RLU222 A26	AECD02 LU2 HQ Extract air (room) temperature control with mixed air dampers, hot water heating coil and DX cooler battery. <i>Options:</i> <ul style="list-style-type: none"> • Minimum and maximum limitation of the supply air temperature • Outside temperature-dependent functions • Remote setpoint readjuster • 2-stage DX cooler battery • Comfort / Protection Mode changeover (time switch) 	
RLU222 A27	AECD05 LU2 HQ Supply air temperature control with mixed air dampers, hot water heating coil and dx cooler battery. <i>Options:</i> <ul style="list-style-type: none"> • Room temperature cascade control • Outside temperature-dependent functions • Remote setpoint readjuster • 2-stage DX cooler battery • Comfort / Protection Mode changeover (time switch) 	
RLU222 A28	AECD03 LU2 HQ Extract air (room) temperature control with mixed air dampers, electric air heater battery and chilled water cooling coil. <i>Options:</i> <ul style="list-style-type: none"> • Minimum and maximum limitation of the supply air temperature • Outside temperature-dependent functions • Remote setpoint readjuster • 2-stage electric air heater battery • Comfort / Protection Mode changeover (time switch) 	
RLU222 A29	AECD06 LU2 HQ Supply air temperature control with mixed air dampers, electric air heater battery and chilled water cooling coil. <i>Options:</i> <ul style="list-style-type: none"> • Room temperature cascade control • Outside temperature-dependent functions • Remote setpoint readjuster • 2-stage electric air heater battery • Comfort / Protection Mode changeover (time switch) 	
RLU222 U01	ADKA02 LU2 HQ Extract air (room) humidity control (r.h.) with spray humidifier. <i>Options:</i> <ul style="list-style-type: none"> • Maximum limitation of the air humidity • Remote setpoint adjuster • 2-stage spray humidifier • Comfort / Protection Mode changeover (time switch) 	

Controller- / basic type	Application no. / description	Plant diagram / connection diagram
RLU222 U02	PB0002 LU2 HQ Differential pressure control of water with speed-controlled pumps. <i>Options:</i> <ul style="list-style-type: none"> • Minimum and maximum pressure limit controller • Outside temperature-dependent functions • Remote setpoint adjuster • Comfort / Protection Mode changeover (time switch) 	
RLU222 U03	AZL002 LU2 HQ Differential pressure control of air with speed-controlled fans. <i>Options:</i> <ul style="list-style-type: none"> • Minimum and maximum pressure limit controller • Outside temperature-dependent functions • Remote setpoint adjuster • Comfort / Protection Mode changeover (time switch) 	
RLU222 U04	ADI003 LU2 HQ Extract air (room) humidity control (r.h.) with DX cooler battery. <i>Options:</i> <ul style="list-style-type: none"> • Additional maximum selection from internal and external signal • Room temperature-dependent shifting of humidity setpoint • Remote setpoint adjuster • 2-stage DX cooler battery • Comfort / Protection Mode changeover (time switch) 	
RLU222 U05	ADI005 LU2 HQ Extract air (room) humidity control (a.h.) with DX cooler battery. <i>Options:</i> <ul style="list-style-type: none"> • Additional maximum selection from internal and external signal • Room temperature-dependent shifting of humidity setpoint • Remote setpoint adjuster • 2-stage DX cooler battery • Comfort / Protection Mode changeover (time switch) 	
RLU222 U06	AAZD02 LU2 HQ Indoor air quality control with mixed air dampers and fan control. <i>Options:</i> <ul style="list-style-type: none"> • Additional maximum selection from internal and external signal • Outside temperature-dependent functions • Remote setpoint adjuster • 2-speed fan • Comfort / Protection Mode changeover (time switch) 	
RLU222 U07	ADZA01 LU2 HQ Extract air (room) humidity control (r.h.) with spray humidifier and DX cooler battery. <i>Options:</i> <ul style="list-style-type: none"> • Maximum limitation of the supply air humidity • Additional maximum selection from internal and external signal • Remote setpoint adjuster • Comfort / Protection Mode changeover (time switch) 	

Controller- / basic type	Application no. / description	Plant diagram / connection diagram
RLU222 U08	CZC001 LU2 HQ Temperature control of chilled ceilings. <i>Options:</i> <ul style="list-style-type: none"> • Setpoint compensation depending on humidity • Deviation alarm • Comfort / Protection Mode changeover (time switch) 	
RLU222 U09	HZC001 LU2 HQ Temperature control of mixing heating circuit. <i>Options:</i> <ul style="list-style-type: none"> • Minimum limitation of the return temperature • Outside temperature-dependent functions • Remote setpoint adjuster • Comfort / Protection Mode changeover (time switch) 	
RLU222 U10	ZZZ001 LU2 HQ 3-position actuator	
RLU222 U11	ZZZ002 LU2 HQ Variable 2-step switch	
RLU222 U12	ADC019 LU2 HQ Universal control (substitute for RKN2 / RKN22) <i>Application:</i> Temperature control (on/off pump control) <i>Options:</i> <ul style="list-style-type: none"> • Remote setpoint adjuster (absolute) • Comfort / Protection Mode changeover (time switch) 	
RLU222 U13	ADC020 LU2 HQ Universal control (substitute for RKN8 / RKN88) <i>Application:</i> Temperature control (modulating valve control) <i>Options:</i> <ul style="list-style-type: none"> • Remote setpoint adjuster (absolute) • Comfort / Protection Mode changeover (time switch) 	

Controller- / basic type	Application no. / description	Plant diagram / connection diagram
RLU222 U14	HZC002 LU2 HQ Boiler temperature control (substitute for RCA12.2) <i>Application:</i> Minimum limitation of the boiler return temperature <i>Options:</i> <ul style="list-style-type: none"> • Remote setpoint adjuster (absolute) • Comfort / Protection Mode changeover (time switch) 	
RLU222 U15	SA0001 LU2 HQ Differential temperature control (substitute for RSA24) <i>Application:</i> Solar heat storage plant <i>Options:</i> <ul style="list-style-type: none"> • Maximum limitation of the boiler temperature • Minimum limitation of the charging temperature 	
RLU222 U16	ABL001 LU2 HQ Supply air differential pressure control <i>Options:</i> <ul style="list-style-type: none"> • Switching via external time switch • Differential pressure monitor 	
RLU222 U17	ADZ001 LU2 HQ Supply air differential pressure control, Extract air volume control <i>Options:</i> <ul style="list-style-type: none"> • Switching via external time switch • Setpoint shift through volumetric supply air flow • Differential pressure monitor 	
RLU222 U18	ADL001 LU2 HQ Supply air and room differential pressure control <i>Options:</i> <ul style="list-style-type: none"> • Switching via external time switch • Differential pressure monitor 	
RLU222 U19	ADZA02 LU2 HQ Extract air (room) humidity control <i>Options:</i> <ul style="list-style-type: none"> • Maximum limitation of supply air humidity • Comfort / Protection Mode changeover (time switch) 	

Controller- / basic type	Application no. / description	Plant diagram / connection diagram
RLU232 A01	AEAF01 LU3 HQ Extract air (room) temperature control with heat recovery, hot water heating coil, frost protection and fan release. <i>Options:</i> <ul style="list-style-type: none"> • Minimum and maximum limitation of the supply air temperature • Outside temperature-dependent functions • Anti-icing protection for heat recovery • Comfort / Economy changeover • Comfort / Protection Mode changeover (time switch) 	
RLU232 A02	AEAF02 LU3 HQ Supply air temperature control with heat recovery, hot water heating coil, frost protection and fan release <i>Options:</i> <ul style="list-style-type: none"> • Room temperature cascade control • Outside temperature-dependent functions • Anti-icing protection for heat recovery • Comfort / Economy changeover • Comfort / Protection Mode changeover (time switch) 	
RLU232 A03	ADC015 LU3 HQ Supply air temperature control with hot water heating coil, frost protection, chilled water cooling coil and fan release <i>Options:</i> <ul style="list-style-type: none"> • Room temperature cascade control • Outside temperature-dependent functions • Comfort / Economy changeover • Comfort / Protection Mode changeover (time switch) 	
RLU232 A04	AECG01 LU3 HQ Extract air (room) temperature control with closed-circuit heat recovery system, hot water heating coil and chilled water cooling coil. <i>Options:</i> <ul style="list-style-type: none"> • Minimum and maximum limitation of the supply air temperature • Outside temperature-dependent functions • Anti-icing protection for heat recovery • Remote setpoint readjuster • Comfort / Economy changeover • Comfort / Protection Mode changeover (time switch) 	
RLU232 A05	AECG02 LU3 HQ Supply air temperature control with closed-circuit heat recovery system, hot water heating coil and chilled water cooling coil. <i>Options:</i> <ul style="list-style-type: none"> • Room temperature cascade control • Outside temperature-dependent functions • Anti-icing protection for heat recovery • Remote setpoint readjuster • Comfort / Economy changeover • Comfort / Protection Mode changeover (time switch) 	
RLU232 A06	AECF01 LU3 HQ Extract air (room) temperature control with heat recovery, hot water heating coil and chilled water cooling coil. <i>Options:</i> <ul style="list-style-type: none"> • Minimum and maximum limitation of the supply air temperature • Outside temperature-dependent functions • Anti-icing protection for heat recovery • Remote setpoint readjuster • Comfort / Economy changeover • Comfort / Protection Mode changeover (time switch) 	

Controller- / basic type	Application no. / description	Plant diagram / connection diagram
RLU232 A07	AECF03 LU3 HQ Supply air temperature control with heat recovery, hot water heating coil and chilled water cooling coil. <i>Options:</i> <ul style="list-style-type: none"> • Room temperature cascade control • Outside temperature-dependent functions • Anti-icing protection for heat recovery • Remote setpoint readjuster • Comfort / Economy changeover • Comfort / Protection Mode changeover (time switch) 	
RLU232 A08	AECF02 LU3 HQ Extract air (room) temperature control with heat recovery, hot water heating coil, frost protection, chilled water cooling coil and fan release. <i>Options:</i> <ul style="list-style-type: none"> • Minimum and maximum limitation of the supply air temperature • Outside temperature-dependent functions • Anti-icing protection for heat recovery • Comfort / Economy changeover • Comfort / Protection Mode changeover (time switch) 	
RLU232 A09	AECF04 LU3 HQ Supply air temperature control with heat recovery, hot water heating coil, frost protection, chilled water cooling coil and fan release. <i>Options:</i> <ul style="list-style-type: none"> • Room temperature cascade control • Outside temperature-dependent functions • Anti-icing protection for heat recovery • Comfort / Economy changeover • Comfort / Protection Mode changeover (time switch) 	
RLU232 A10	ADC009 LU3 HQ Extract air (room) temperature control with hot water heating coil and 2 chilled water cooling coils. <i>Options:</i> <ul style="list-style-type: none"> • Minimum and maximum limitation of the supply air temperature • Outside temperature-dependent functions • Remote setpoint readjuster • Comfort / Economy changeover • Comfort / Protection Mode changeover (time switch) 	
RLU232 A11	ADC018 LU3 HQ Supply air temperature control with hot water heating coil and 2 chilled water cooling coils. <i>Options:</i> <ul style="list-style-type: none"> • Room temperature cascade control • Outside temperature-dependent functions • Remote setpoint readjuster • Comfort / Economy changeover • Comfort / Protection Mode changeover (time switch) 	
RLU232 A12	AEDK01 LU3 HQ Supply air temperature control and room humidity control (r.h.) with heat recovery, hot water heating coil and spray humidifier. <i>Options:</i> <ul style="list-style-type: none"> • Room temperature cascade control • Maximum limitation of the supply air humidity • Outside temperature-dependent functions • Comfort / Economy changeover • Comfort / Protection Mode changeover (time switch) 	

Controller- / basic type	Application no. / description	Plant diagram / connection diagram
RLU232 A13	ADE001 LU3 HQ Extract air (room) temperature control and dewpoint control with hot water preheating coil, frost protection, chilled water cooling coil, hot water reheating coil and fan release. <i>Options:</i> <ul style="list-style-type: none"> • Minimum and maximum limitation of the supply air temperature • Outside temperature-dependent functions • Comfort / Economy changeover • Comfort / Protection Mode changeover (time switch) 	
RLU232 A14	ADFA01 LU3 HQ Supply air temperature and extract air (room) humidity control (r.h.) with hot water heating coil, frost protection, spray humidifier, chilled water cooling coil and fan release. <i>Options:</i> <ul style="list-style-type: none"> • Maximum limitation of the supply air humidity • Outside temperature-dependent functions • Comfort / Economy changeover • Comfort / Protection Mode changeover (time switch) 	
RLU232 A15	ADFA02 LU3 HQ Extract air (room) temperature control and dew point control with hot water preheating coil, frost protection, spray humidifier, chilled water cooling coil, hot water reheating coil and fan release. <i>Options:</i> <ul style="list-style-type: none"> • Minimum and maximum limitation of the supply air temperature • Additional maximum selection from internal and external signal • Comfort / Economy changeover • Comfort / Protection Mode changeover (time switch) 	
RLU232 A16	AEFH01 LU3 HQ Supply air temperature and room humidity control (r.h.) with mixed air dampers, hot water heating coil, frost protection, chilled water cooling coil, spray humidifier and fan release. <i>Options:</i> <ul style="list-style-type: none"> • Room temperature cascade control • Outside temperature-dependent functions • Comfort / Economy changeover • Comfort / Protection Mode changeover (time switch) 	
RLU232 A17	AECD01 LU3 HQ Extract air (room) temperature control and mixed air temperature control <i>Options:</i> <ul style="list-style-type: none"> • Minimum and maximum limitation of supply air temperature • Outside temperature-dependent functions • Comfort / Economy changeover • Comfort / Protection Mode changeover (time switch) 	
RLU232 U01	ABA001 LU3 HQ 2 independent supply air temperature control systems with hot water heating coils. <i>Options:</i> <ul style="list-style-type: none"> • 2 independent remote setpoint adjusters • Outside temperature-dependent functions • Comfort / Protection Mode changeover (time switch) 	
RLU232 U02	ADL001 LU3 HQ Supply and extract air volume control with fan control. <i>Options:</i> <ul style="list-style-type: none"> • 2 independent remote setpoint adjusters • Outside temperature-dependent functions • Comfort / Protection Mode changeover (time switch) 	

Controller- / basic type	Application no. / description	Plant diagram / connection diagram
RLU232 U03	ZZZ003 LU3 HQ Linear 2-step switch	
RLU232 U04	ZZZ004 LU3 HQ Binary 2-step switch	
RLU232 U05	ZZZ005 LU3 HQ Variable 2-step switch	
RLU236 A01	ADA007 LU3 HQ Extract air (room) temperature control with electric air heater battery. <i>Options:</i> <ul style="list-style-type: none"> • Min. and max. limitation of the supply air temperature • Outside temperature-dependent functions • Remote setpoint readjuster • 6-stage electric air heater battery • Comfort / Economy changeover • Comfort / Protection Mode changeover (time switch) 	
RLU236 A02	ADA013 LU3 HQ Supply air temperature control with electric air heater battery. <i>Options:</i> <ul style="list-style-type: none"> • Room temperature cascade control • Outside temperature-dependent functions • Remote setpoint readjuster • 6-stage electric air heater battery • Comfort / Economy changeover • Comfort / Protection Mode changeover (time switch) 	
RLU236 A03	ADB004 LU3 HQ Extract air (room) temperature control with DX cooler battery. <i>Options:</i> <ul style="list-style-type: none"> • Min. and max. limitation of the supply air temperature • Outside temperature-dependent functions • Remote setpoint readjuster • 6-stage dx cooler battery • Comfort / Economy changeover • Comfort / Protection Mode changeover (time switch) 	
RLU236 A04	ADB008 LU3 HQ Supply air temperature control with DX cooler battery. <i>Options:</i> <ul style="list-style-type: none"> • Room temperature cascade control • Outside temperature-dependent functions • Remote setpoint readjuster • 6-stage DX cooler battery • Comfort / Economy changeover • Comfort / Protection Mode changeover (time switch) 	

Controller- / basic type	Application no. / description	Plant diagram / connection diagram
RLU236 A05	ADC005 LU3 HQ Extract air (room) temperature control with electric air heater battery and DX cooler battery. <i>Options:</i> <ul style="list-style-type: none"> • Minimum and maximum limitation of the supply air temperature • Outside temperature-dependent functions • Remote setpoint readjuster • 4-stage electric air heater battery • 2-stage DX cooler battery • Comfort / Economy changeover • Comfort / Protection Mode changeover (time switch) 	
RLU236 A06	ADC013 LU3 HQ Supply air temperature control with electric air heater battery and DX cooler battery. <i>Options:</i> <ul style="list-style-type: none"> • Room temperature cascade control • Outside temperature-dependent functions • Remote setpoint readjuster • 4-stage electric air heater battery • 2-stage DX cooler battery • Comfort / Economy changeover • Comfort / Protection Mode changeover (time switch) 	
RLU236 A07	ADC008 LU3 HQ Extract air (room) temperature control with hot water air heating coil, frost protection, DX cooler battery and fan release. <i>Options:</i> <ul style="list-style-type: none"> • Minimum and maximum limitation of the supply air temperature • Outside temperature-dependent functions • Remote setpoint readjuster • 4-stage DX cooler battery • Comfort / Economy changeover • Comfort / Protection Mode changeover (time switch) 	
RLU236 A08	ADC017 LU3 HQ Supply air temperature control with hot water heating coil, frost protection, DX cooler battery and fan release. <i>Options:</i> <ul style="list-style-type: none"> • Room temperature cascade control • Outside temperature-dependent functions • Remote setpoint readjuster • 4-stage DX cooler battery • Comfort / Economy changeover • Comfort / Protection Mode changeover (time switch) 	
RLU236 A09	AEDL01 LU3 HQ Supply air temperature and supply air humidity control (r.h.) with closed-circuit heat recovery system, hot water heating coil, frost protection, spray humidifier and fan release. <i>Options:</i> <ul style="list-style-type: none"> • Room temperature cascade control • Outside temperature-dependent functions • Comfort / Economy changeover • Comfort / Protection Mode changeover (time switch) 	
RLU236 A10	AEFL01 LU3 HQ Supply air temperature and supply air humidity control (r.h.) with closed-circuit heat recovery system, DX cooler battery, hot water heating coil, frost protection, spray humidifier and fan release. <i>Options:</i> <ul style="list-style-type: none"> • Room temperature cascade control • Outside temperature-dependent functions • 2-stage DX cooler battery • Comfort / Economy changeover • Comfort / Protection Mode changeover (time switch) 	

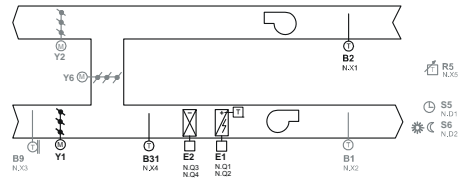
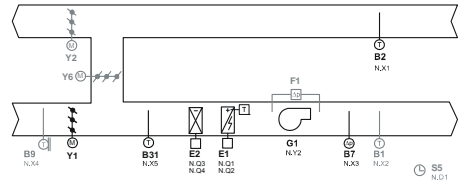
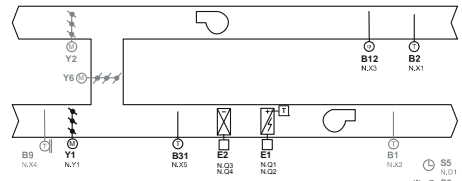
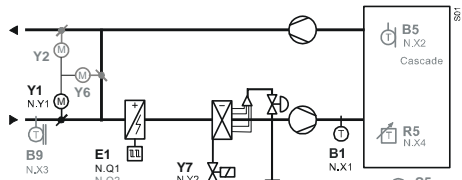
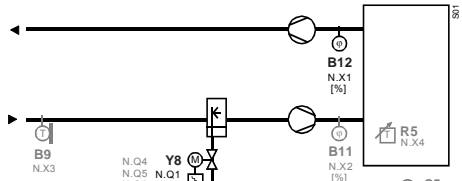
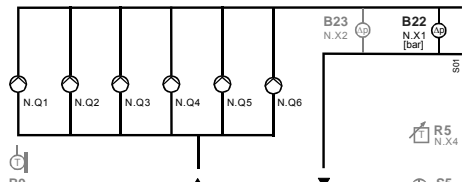
Controller- / basic type	Application no. / description	Plant diagram / connection diagram
RLU236 A11	AECD02 LU3 HQ Extract air (room) temperature control and mixed air temperature control <i>Options:</i> <ul style="list-style-type: none"> • Minimum and maximum limitation of supply air temperature • Outside temperature-dependent functions • Remote setpoint readjuster • 2-stage electric air heater battery • 2-stage direct expansion cooler battery • Comfort / Economy changeover • Comfort / Protection Mode changeover (time switch) 	
RLU236 A12	AEZD01 LU3 HQ Extract air (room) temperature and mixed air temperature control and supply air differential pressure control <i>Options:</i> <ul style="list-style-type: none"> • Minimum and maximum limitation of supply air temperature • Outside temperature-dependent functions • 2-stage electric air heater battery • 2-stage direct expansion cooler battery • Comfort / Economy changeover • Comfort / Protection Mode changeover (time switch) 	
RLU236 A13	AEGD01 LU3 HQ Extract air (room) temperature and mixed air temperature control and humidity control <i>Options:</i> <ul style="list-style-type: none"> • Minimum and maximum limitation of supply air temperature • Outside temperature-dependent functions • 2-stage electric air heater battery • 2-stage direct expansion cooler battery • Comfort / Economy changeover • Comfort / Protection Mode changeover (time switch) 	
RLU236 A14	AECD03 LU3 HQ Supply air temperature control <i>Options:</i> <ul style="list-style-type: none"> • Room temperature cascade control • Outside temperature-dependent functions • Remote setpoint readjuster • 4-stage electric air heater battery • 2-stage direct expansion cooler battery • Comfort / Economy changeover • Comfort / Protection Mode changeover (time switch) 	
RLU236 U01	ADKA03 LU3 HQ Extract air (room) humidity control (r.h.) with spray humidifier. <i>Options:</i> <ul style="list-style-type: none"> • Maximum limitation of the supply air humidity • Outside temperature-dependent functions • Remote setpoint adjuster • 6-stage spray humidifier • Comfort / Economy changeover • Comfort / Protection Mode changeover (time switch) 	
RLU236 U02	PB0003 LU3 HQ Differential pressure control of water with load-dependent pump control. <i>Options:</i> <ul style="list-style-type: none"> • Minimum and maximum pressure limit controller • Outside temperature-dependent functions • Remote setpoint adjuster • Comfort / Economy changeover • Comfort / Protection Mode changeover (time switch) 	

Controller- / basic type	Application no. / description	Plant diagram / connection diagram
RLU236 U03	AZL003 LU3 HQ Differential pressure control of air with load-dependent fan control. <i>Options:</i> <ul style="list-style-type: none"> • Minimum and maximum pressure limit controller • Outside temperature-dependent functions • Remote setpoint adjuster • Comfort / Economy changeover • Comfort / Protection Mode changeover (time switch) 	
RLU236 U04	ADI004 LU3 HQ Extract air (room) humidity control (r.h.) with DX cooler battery. <i>Options:</i> <ul style="list-style-type: none"> • Additional maximum selection from internal and external signal • Room temperature-dependent shifting of humidity setpoint • Remote setpoint adjuster • 6-stage DX cooler battery • Comfort / Economy changeover • Comfort / Protection Mode changeover (time switch) 	
RLU236 U05	ADI006 LU3 HQ Extract air (room) humidity control (a.h.) with DX cooler battery. <i>Options:</i> <ul style="list-style-type: none"> • Additional maximum selection from internal and external signal • Room temperature-dependent shifting of humidity setpoint • Remote setpoint adjuster • 6-stage DX cooler battery • Comfort / Economy changeover • Comfort / Protection Mode changeover (time switch) 	
RLU236 U06	AAZD03 LU3 HQ Indoor air quality control with mixed air dampers and fan control. <i>Options:</i> <ul style="list-style-type: none"> • Additional maximum selection from internal and external signal • Outside temperature-dependent functions • Remote setpoint adjuster • 6-speed fan • Comfort / Economy changeover • Comfort / Protection Mode changeover (time switch) 	
RLU236 U07	ADZA02 LU3 HQ Extract air (room) humidity control (r.h.) with spray humidifier and DX cooler battery. <i>Options:</i> <ul style="list-style-type: none"> • Maximum limitation of supply air humidity • Additional maximum selection from internal and external signal • Remote setpoint adjuster • 2-stage spray humidifier • 4-stage DX cooler battery • Comfort / Economy changeover • Comfort / Protection Mode changeover (time switch) 	
RLU236 U08	ZZZ006 LU3 HQ Linear 3-step switch	

Controller- / basic type	Application no. / description	Plant diagram / connection diagram
RLU236 U09	ZZZ007 LU3 HQ Linear 4-step switch	
RLU236 U10	ZZZ008 LU3 HQ Linear 5-step switch	
RLU236 U11	ZZZ009 LU3 HQ Linear 6-step switch	
RLU236 U12	ZZZ010 LU3 HQ Variable 3-step switch	
RLU236 U13	ZZZ011 LU3 HQ Variable 4-step switch	
RLU236 U14	ZZZ012 LU3 HQ Variable 5-step switch	

Controller- / basic type	Application no. / description	Plant diagram / connection diagram
RLU236 U15	ZZZ013 LU3 HQ Variable 6-step switch	
RLU236 U16	ZZZ014 LU3 HQ Binary step switch with 7 steps (3 relays)	
RLU236 U17	ZZZ015 LU3 HQ Binary step switch with 15 steps (4 relays)	
RLU236 U18	CZZ001 LU3 HQ Condensation pressure control <i>Options:</i> • Switching via external time switch	

Dimensions (dimensions in mm)

RLU202,
RLU220, RLU222

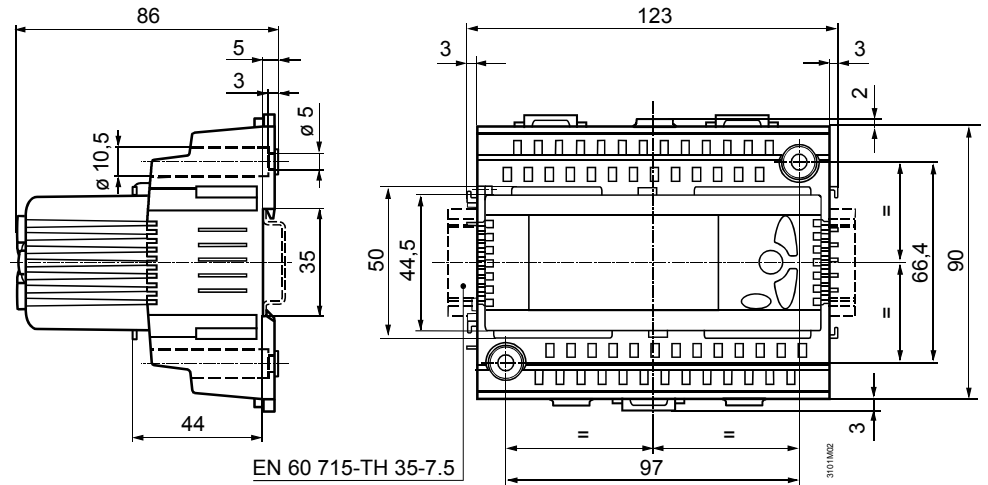

RLU232, RLU236

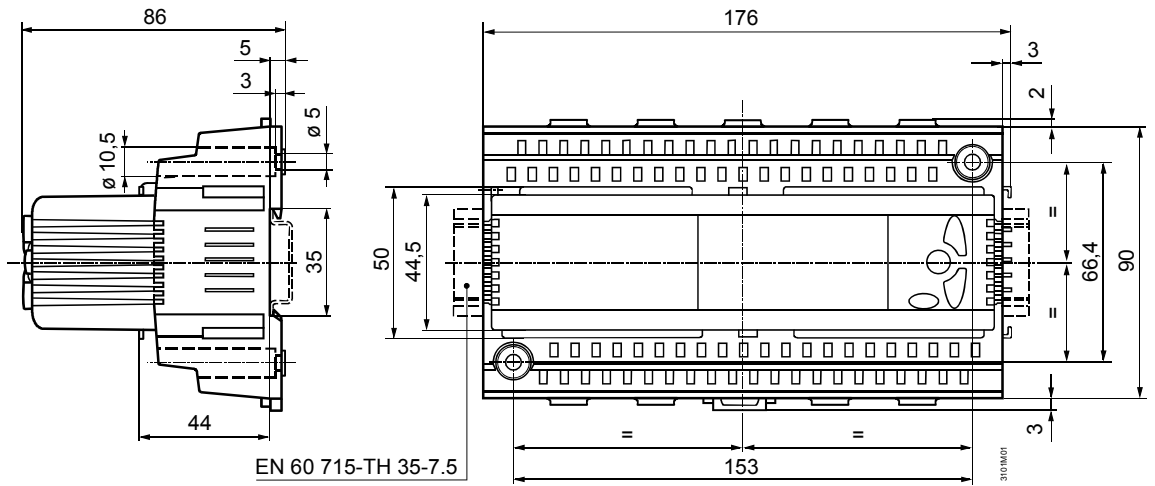

ARG62.201

Mounting frame for **RLU202, RLU220 and RLU222:**

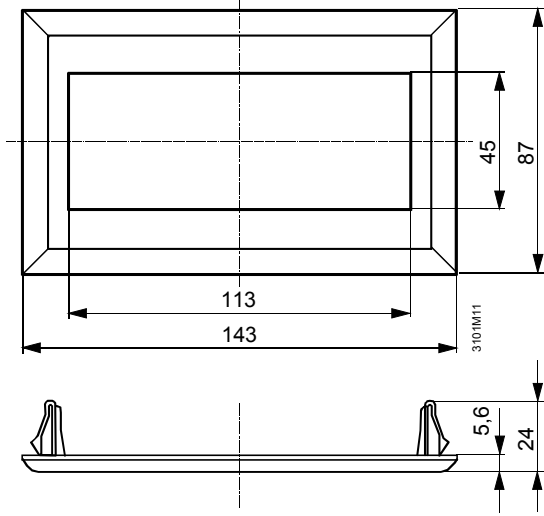

Mounting frame for **RLU232 and RLU236:**

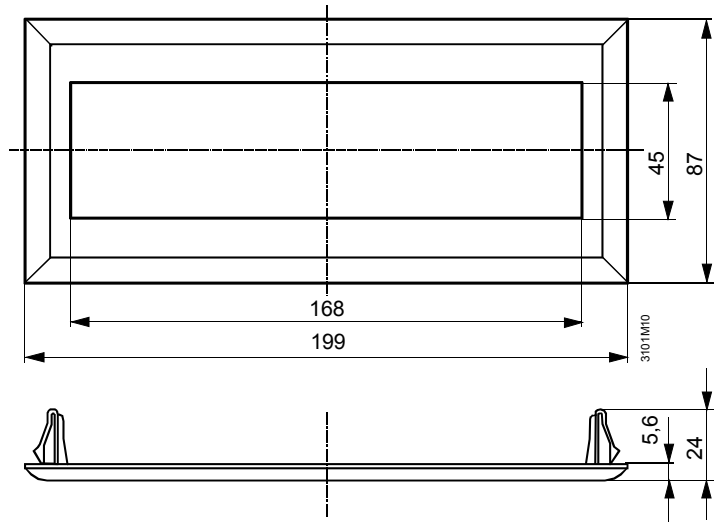

Panel cutout if controller shall be wired prior to mounting:

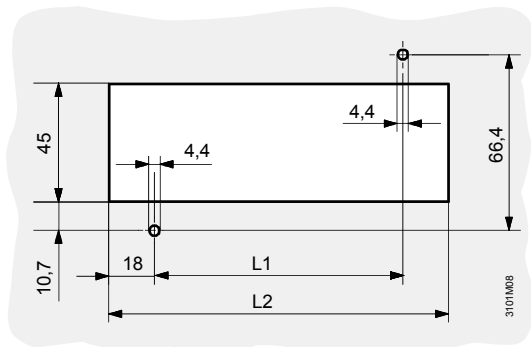

Type	L1	L2
RLU202, RLU220, RLU222	97	133
RLU232, RLU236	153	189

Panel cutout if controller shall be wired after mounting:

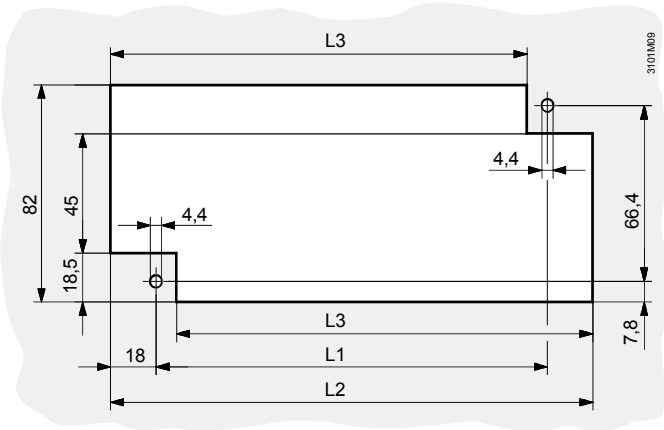

Type	L1	L2	L3
RLU202, RLU220, RLU222	97	133	107
RLU232, RLU236	153	189	163